

FR600 series inverters fast installation and commissioning guide

Step 1. Checking the inverter model No.

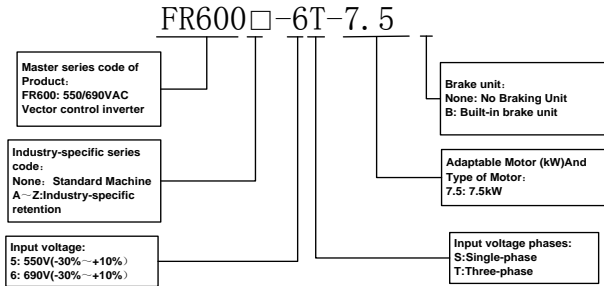

Figure 1 Produce Model No. Naming Rule

Step 2. Wirings

By step 1 to check and confirm that the purchased inverter is what user need, and then wirings as below:

1. Main circuit wiring

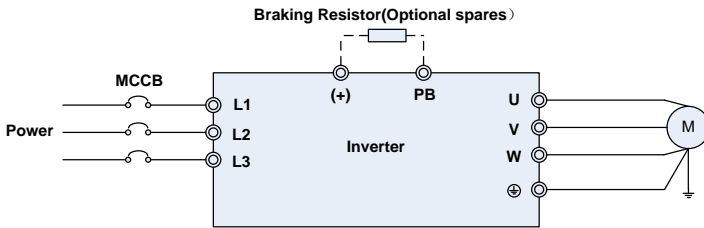

Figure 2 Main Circuit Wirings

| Terminal marks | Designation and function of terminals. |
|----------------|---|
| R/L1、S/L2、T/L3 | AC power input terminals for connecting to 3-phase AC380V power supply. |
| U/T1、V/T2、W/T3 | AC output terminals of inverter for connecting to 3-phase induction motor. |
| (+), (-) | Positive and negative terminals of internal DC bus. |
| PB | Positive and negative terminals of internal DC bus. Connecting terminals of braking resistor. One end connected to + and the other to PB. |
| ⊕ | Grounding terminal. |

2. Control circuit wirings

Different control circuit wirings for different applications, for FRECON product quick-menu, here take some normal-used wirings as example below:

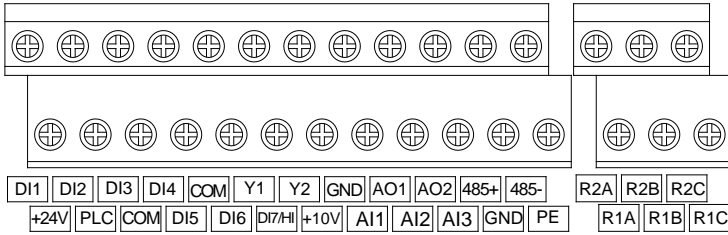

Figure 3 FR600 series Control Terminal Diagram

2.1 Frequency given by keypad potentiometer, start or stop the machine controlled by RUN and STOP button on keypad. Control circuits no need to be wired, directly work with power on.

2.2 Frequency given by external potentiometer, start or stop the machine controlled by external switch, Control circuit wirings as below:

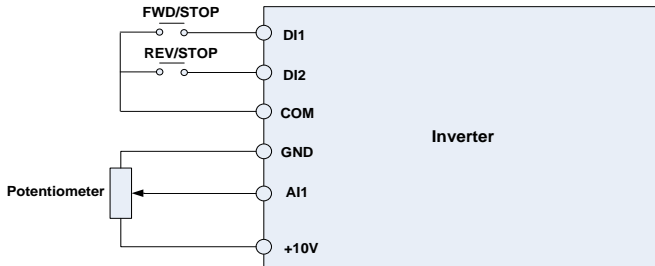

Figure 4 Control terminal wirings

Parameters need to be set as below:

| | | | |
|--------|-------------------------------------|--|---|
| F01.01 | Main frequency source given mode | 2: AI1 | 2 |
| F02.00 | Start/stop command source selection | 1: External terminal (LED light turn on) | 1 |

2.3 Frequency given by PID, start/stop controlled by external switch, take constant pressure water supply as an example, control wirings as below:

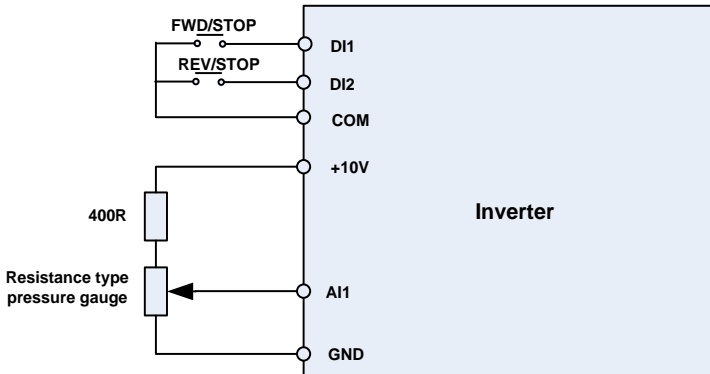

Figure 5 Control Terminal Wirings

Parameters need to be set as below:

| | | | |
|--------|-------------------------------------|--|-------|
| F01.01 | Main frequency source given mode | 6: Process PID | 6 |
| F02.00 | Start/stop command source selection | 1: External terminal (LED light turn on) | 1 |
| F13.01 | PID Digital Given | 0.0~100.0% | 25.0% |
| F13.08 | Proportional Gain Kp1 | 0.0~100.0 | 1.0 |
| F13.09 | Integration Time Ti1 | 0.01~10.00s | 0.10s |

3. Integrated Wirings Diagram

In many cases, besides the above control wirings, inverter's fault signal and frequency signal need to be transferred to upper machine, control signal output and fault reset function added base on figure 2.2 application mode, inverter's integrated wirings diagram as below:

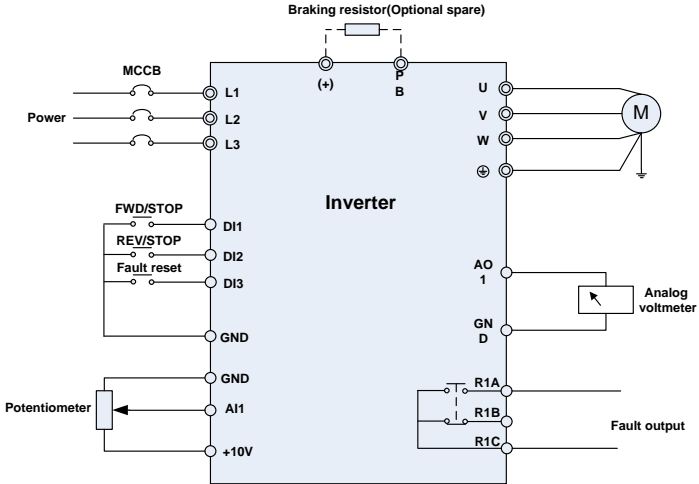

Figure 6 Integrated Wirings

Step 3 Operations and Display Interface Introduction

Operation panel is a Human-Machine-Interface (HMI), which can change the inverter function parameter, monitor the inverter work situation, control the inverter run/stop, etc. The appearance and functional area as below:













Figure 7 Operation panel diagram

3.1 Operation panel button and potentiometer function

There are 8 buttons and 1 analog potentiometer, functions of every button as table 1.

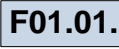
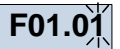









Table 1 Operation Panel Buttons Function Table

| Symbol | Name | Function |
|---|------------------|--|
|  | Escape | Enter or exit Level I menu |
|  | Enter | Enter the menu interfaces level by level, and confirm the parameter setting |
|  | Increment | Increase data or function code |
|  | Decrement | Decrease data or function code |
|  | Shift | Select the displayed parameters in turn in the stop or running state, and select the digit to be modified when modifying parameters |
|  | Multifunction | Perform function switchover (such as jog run and quick switchover of command source or direction) according to the setting of F16.00 |
|  | potentiometer | With the same function as AI1/AI2 |
|  | Run | Start the inverter in the keypad control mode |
|  | Stop/Reset | Stop the inverter when it is in the running state and perform the reset operation when it is in the fault state. The functions of this key are restricted in F16.01. |
|  | Key combinations | The inverter will free stop when the run and stop key are pressed simultaneously |

3.2 Quick-menu (user customized parameters) instruction

For ease of normal-used parameters quick setting, FR series inverters software version higher than V1.07, factory menu mode changed to quick-menu (F00.01=1), default quick parameters refer to schedule.

Display difference between quick menu and basic menu (F00.01=0) is 2nd grade, for ease of user distinguish the difference and switch method as below:

| Menu Mode | Quick Menu | Basic Menu |
|---------------------------------------|---|---|
| Display Difference (2 nd) |  Function code last digit with decimal point, no flash. |  Function code last digit no decimal point, flash. |
| Functional Distinction | 1、 Press  or  , set function code switch up or down according to F17 group. 2、 Press  can't go back 1 st grade menu. | 1、 Press  or  , switch up or down according to order of function code 01, 02... 2、 Press  can go back to 1 st grade menu.  |
| Inter-switch | Method 1, switch to basic menu by changing F00.01=0. Method 2, when show 2 nd menu, keep press  button, auto-switch to basic menu. | Method 1, switch to quick menu by changing F00.01=1. Method 2, when show 2 nd menu, keep press  button, auto-switch to quick-menu. |

If the default quick-parameters can't meet the user demand, user can self-define the quick-parameters according to the actual situation; detailed method is to change F17 group function code.

F17 group supply max 30 groups of user customized parameters, F17 group parameter show value 00.00, means the user function code is null. When entering user-defined parameter mode, displayed function code defined by F17-00~F17-29, order keep the same with F17 group, skip on 00.00. Two digits in left side of decimal point mean function code group, right side mean the position of the function code group. For example: 05.15 means F05.15. F00~F20 group corresponds to decimal point left side two digits 00~20, U00 and U01 group corresponds to 48 and 49. Set as 21~46 mean the user function code null. When right side 2 digits per group more than setting group function code number, also mean user function code null.

Appendix: shortcut menu factory parameter

| Param. | Parameter Name | Setting Range | Default | Attr |
|--------|---------------------------------|--|---------|------|
| F00.00 | Setting of User Password | 0~65535 | 0 | × |
| F00.01 | Display of Parameters | 0: Display all parameters | 1 | × |
| | | 1: Only display F00.00, F00.01 and user-defined parameters F17.00~F17.29 | | |
| | | 2: Only display A0-00, A0-01, and the parameters different with factory default | | |
| F00.03 | G/P type display | 0: G type (constant torque load) 1: P type (variable torque load e.g. fan and pump) | 0 | × |
| F01.01 | Master Frequency Command Source | 0: Master digital setting (F01.02) | 1 | × |
| | | 1: keypad potentiometer | | |
| | | 2: Analog input AI1 | | |
| | | 3: Communication | | |
| | | 4: Multi-reference | | |
| | | 5: PLC | | |
| | | 6: Process PID output | | |
| | | 7: X7/HI pulse input | | |
| | | 8: AI2 | | |
| 9: AI3 | | | | |
| F02.00 | Run command | 0: Keypad control (LED off) | 0 | × |
| | | 1: Terminal control (LED on) | | |
| | | 2: Communication control (LED blinking) | | |
| F02.01 | Running direction | 0: Forward | 0 | △ |
| | | 1: Reverse | | |
| F02.12 | Stop mode | 0: Ramp to stop | 0 | × |
| | | 1: Coast to stop | | |

| | | | | |
|--|----------------------------|--|---------------|---|
| F03.00 | Accel time 0 | 0.0~6000.0s | 15.0s | △ |
| F03.01 | Decel time 0 | 0.0~6000.0s | 15.0s | △ |
| F04.00 | Function of terminal DI1 | 0: No function | 1 | × |
| F04.01 | Function of terminal DI2 | 1: Running forward (FWD) | 2 | × |
| F04.02 | Function of terminal DI3 | 2: Running reverse (REV) | 7 | × |
| F04.03 | Function of terminal DI4 | 3: Three-wire control | 13 | × |
| F05.02 | Relay 1 output function | 2: Fault output | 2 | × |
| F08.01 | Power rating of motor 1 | 0.1~1000.0kW | Model defined | × |
| F08.02 | Rated voltage of motor 1 | 60~660V | Model defined | × |
| F08.03 | Rated current of motor 1 | 0.1~1500.0A | Model defined | × |
| F08.04 | Rated frequency of motor 1 | 20.00~Fmax | Model defined | × |
| F08.05 | Rated speed of motor 1 | 1~30000 | Model defined | × |
| F08.30 | Autotuning of motor 1 | 0: No autotuning | 0 | × |
| | | 1: Static autotuning of async motor | | |
| | | 2: Rotary autotuning of async motor | | |
| F11.10 | Protection action 1 | Unit's place: Bus undervoltage | 03000 | × |
| | | 0: Fault reported and coast to stop | | |
| | | 1: Stop according to the stop mode | | |
| | | 2: Fault reported but continue to run | | |
| | | 3: Fault protection disabled | | |
| | | Ten's digit :Power input phase Loss (Err09)(Same as unit's place) | | |
| | | Hundred's digit :Power output phase loss(Err10)(Same as unit's place) | | |
| | | Thousand's digit:Motor overload (Err11)(Same as unit's place) | | |
| Ten thousand's digit:Inverter overload(Err11)(Same as unit's place) | | | | |
| F13.00 | PID setting | 0: F13.01 digital setting | 0 | × |
| | | 1:keypad potentiometer | | |
| | | 2:AI1 | | |
| | | 3: Communication | | |
| | | 4: Multi-Reference | | |
| | | 5: DI7/HI pulse input | | |
| | | 6: AI2 | | |

| | | | | |
|--------|--------------------------|------------------|-------|---|
| | | 7:AI3 | | |
| F13.01 | PID digital setting | 0.0~100.0% | 50.0% | Δ |
| F13.02 | PID feedback | 0: AI1 | 0 | × |
| | | 1: AI2 | | |
| | | 2: Communication | | |
| F13.08 | Proportional gain Kp1 | 0.0~100.0 | 1.0 | Δ |
| F13.09 | Integration time Ti1 | 0.01~10.00s | 0.10s | Δ |

Preface

Thank you for choosing FRECON developed and produced FR600 series vector control inverter.

FR600 series vector control inverter is mainly positioned as a high-end market for OEM customers and the specific requirements of fan and pump load applications, its flexible design, both embedded SVC and VF control in one, can be widely used for speed control accuracy, torque response speed, low-frequency output characteristics and other situations with higher requirements.

This user manual supplies a detailed description of FR600 series vector control inverter includes product characterization, structural features, parameter setting, operation and commissioning, inspection maintenance and other contents. Be sure to carefully read through the safety precautions before use, and use this product on the premise that personnel and equipment safety is ensured.

IMPORTANT NOTES

- ◆ To illustrate the details of the products, pictures in this manual based on products with outer casing or safety cover being removed. When using this product, please be sure to well install outer casing or covering by the rules, and operating in accordance with the manual contents.
- ◆ The illustrations this manual for illustration only and may vary with different products you have ordered.
- ◆ The company is committed to continuous improvement of products, product features will continue to upgrade, the information provided is subject to change without notice.
- ◆ If you are using have questions, please contact our regional agents or our customer service center. Customer Service Tel 0755 -33067999.
- ◆ The company's other products please visit our website. <http://www.frecon.com.cn>

Contents

| | |
|---|---------------|
| PREFACE | - 8 - |
| CONTENTS | - 9 - |
| CHAPTER 1 SAFETY PRECAUTIONS | - 11 - |
| 1.1 SAFETY CONSIDERATIONS | - 11 - |
| 1.2 PRECAUTIONS | - 13 - |
| CHAPTER 2 PRODUCT INFORMATION | - 15 - |
| 2.1 NAMEPLATE INFORMATION | - 15 - |
| 2.2 INFORMATION OF FR600 PRODUCT MODEL | - 16 - |
| 2.3 TECHNICAL FEATURES OF FR600 | - 17 - |
| 2.4 PARTS DRAWING | - 19 - |
| 2.5 CONFIGURATION, MOUNTING DIMENSIONS AND WEIGHT | - 20 - |
| 2.6 FLANGE MOUNTING DIMENSIONS | - 21 - |
| 2.7 EXTERNAL DIMENSIONS OF KEYPAD | - 22 - |
| CHAPTER 3 INSTALLATION AND WIRING | - 24 - |
| 3.1 INSTALLATION ENVIRONMENT | - 24 - |
| 3.2 INSTALLATION DIRECTION, SPACE AND COOLING | - 24 - |
| 3.3 FIXED MANNER | - 26 - |
| 3.4 WIRING WAY | - 27 - |
| 3.5 TERMINAL CONFIGURATION | - 28 - |
| 3.6 EMI SOLUTIONS | - 33 - |
| CHAPTER 4 OPERATION AND DISPLAY | - 36 - |
| 4.1 INTRODUCTION OF KEYPAD | - 36 - |
| 4.2 VIEWING AND MODIFYING FUNCTION CODES | - 38 - |
| 4.3 VIEWING STATUS PARAMETERS | - 38 - |
| 4.4 MOTOR AUTO-TUNING | - 39 - |
| 4.5 PASSWORD SETTING | - 39 - |
| 4.6 KEYPAD LOCK | - 39 - |
| 4.7 SHORTCUT MENU FUNCTION CODE DESCRIPTION | - 39 - |
| CHAPTER 5 LIST OF PARAMETER | - 41 - |
| 5.1 FIVE LED (DIGITAL) DISPLAY INDICATORS | - 42 - |
| 5.1 STANDARD FUNCTION PARAMETERS | - 42 - |
| CHAPTER 6 SPECIFICATION OF PARAMETERS | - 68 - |
| GROUP F00 SYSTEM PARAMETERS | - 68 - |
| GROUP F01 FREQUENCY COMMAND | - 71 - |
| GROUP F02 START/STOP CONTROL START/STOP CONTROL | - 74 - |
| GROUP F03 ACCEL/DECEL PARAMETERS | - 78 - |
| GROUP F04 DIGITAL INPUT | - 80 - |
| GROUP F05 DIGITAL OUTPUT | - 87 - |
| GROUP F06 ANALOG AND PULSE INPUT | - 91 - |
| GROUP F07 ANALOG AND PULSE OUTPUT | - 95 - |
| GROUP F08 PARAMETERS OF MOTOR 1 | - 96 - |
| GROUP F09 V/F CONTROL PARAMETERS OF MOTOR 1 | - 97 - |
| GROUP F10 VECTOR CONTROL PARAMETERS OF MOTOR 1 | - 100 - |

| | |
|--|----------------|
| GROUP F11 PROTECTION PARAMETERS | - 103 - |
| GROUP F12 MULTI-REFERENCE AND SIMPLE PLC FUNCTION | - 108 - |
| GROUP F13 PROCESS PID | - 112 - |
| GROUP F14 SWING FREQUENCY, FIXED LENGTH, COUNT AND WAKEUP..... | - 115 - |
| GROUP F15 COMMUNICATION PARAMETERS | - 118 - |
| GROUP F16 KEYS AND DISPLAY OF KEYPAD PARAMETERS..... | - 119 - |
| GROUP F17 USER-DEFINED DISPLAY PARAMETERS | - 120 - |
| GROUP F22 VIRTUAL IO..... | - 121 - |
| GROUP U00 STATUS MONITORING | - 122 - |
| GROUP U01 FAULT RECORD | - 123 - |
| CHAPTER 7 MAINTENANCE AND TROUBLESHOOTING | - 125 - |
| CHAPTER 8 MAINTENANCE AND INSPECTION | - 129 - |
| 8.1 INSPECTION..... | - 129 - |
| 8.2 MAINTENANCE | - 130 - |
| APPENDIX A: MODBUS COMMUNICATION PROTOCOL..... | - 132 - |

Chapter 1 Safety Precautions

Safety Precautions





Safety signs in this manual:









 **DANGER:** indicates the situation in which the failure to follow operating requirements may result in fire or serious personal injury or even death.

 **CAUTION:** indicates the situation in which the failure to follow operating requirements may cause moderate or slight injury and damage to equipment.

Users are requested to read this chapter carefully when installing, commissioning and repairing this product and perform the operation according to safety precautions as set forth in this chapter without fail. FRECON will bear no responsibility for any injury and loss as a result of any violation operation.

1.1 Safety Considerations

| The use phase | Safety class | Considerations |
|---------------------|---|---|
| Before Installation |  Danger | <ul style="list-style-type: none"> ◆ Do not install the product if the package is with water, or component is missing or broken. ◆ Do not install the product if the label on the package is not identical to that on the inverter. |
| |  Caution | <ul style="list-style-type: none"> ◆ Be careful of carrying or transportation. Risk of devices damage. ◆ Do not use damaged product or the inverters missing component .Risk of injury. ◆ Do not touch the parts of control system with bare hands. Risk of ESD hazard. |
| Installation |  Danger | <ul style="list-style-type: none"> ◆ Installation base shall be metal or other non-flammable material. Risk of fire. ◆ Do not install inverter in an environment containing explosive gases, otherwise there is danger of explosion. ◆ Do not unscrew the fixing bolts, especially the bolts with red mark. |
| |  Caution | <ul style="list-style-type: none"> ◆ Do not leave cable strips or screws in the inverter. Risk of inverter damage. ◆ Install the product at the place with less vibration and no direct sunlight. ◆ Consider the installation space for cooling purpose when two or more inverters are placed in the same cabinet. |
| Wiring |  Danger | <ul style="list-style-type: none"> ◆ Wiring must be performed by authorized and qualified personnel. Risk of danger. ◆ Circuit-breaker should be installed between inverter and the mains. Risk of fire. ◆ Make sure the input power supply has been completely disconnected before wiring. Failure to comply may result in personnel injury and/or equipment damage. ◆ Since overall leakage current of this equipment may be bigger than 3.5mA, for safety's sake, this equipment and its associated motor must be well grounded so as to avoid risk of electric shock. ◆ Never connect the power cables to the output terminals (U/T1、V/T2、W/T3) of the AC drive. Pay attention to the marks of the |

| | | |
|------------------|--|--|
| | | <p>wiring terminals and ensure correct wiring. Failure to comply will result in damage to the AC drive.</p> <ul style="list-style-type: none"> ◆ Install braking resistors at terminals (+) and PB only. Failure to comply may result in equipment damage. ◆ AC 220V signal is prohibited from connecting to other terminals than control terminals R1A, R1B, R1C and R2A, R2B, R2C. Failure to comply may result in equipment damage. |
| |  Caution | <ul style="list-style-type: none"> ◆ Since all adjustable frequency AC drives from FRECON have been subjected to hi-pot test before delivery, users are prohibited from implementing such a test on this equipment. Failure to comply may result in equipment damage. ◆ Signal wires should to the best of the possibility be away from main power lines. If this cannot be ensured, vertical cross-arrangement shall be implemented, otherwise interference noise to control signal may occur. ◆ If motor cables are longer than 100m, it is recommended output AC reactor be used. Failure to comply may result in faults. |
| Before Power-on |  Danger | <ul style="list-style-type: none"> ◆ Inverter shall be power-on only after the front cover is assembled. Risk of electrical hazard. |
| |  Caution | <ul style="list-style-type: none"> ◆ Verify that the input voltage is identical to the rated voltage of product, correct wiring of input terminals R/L1, S/L2, and T/L3 and output terminals U/T1, V/T2, and W/T3, wiring of inverter and its peripheral circuits, and all wires should be in good connection. Risk of inverter damage. |
| After Power-on |  Danger | <ul style="list-style-type: none"> ◆ Do not open the cover after power. Risk of electrical hazard. ◆ Do not touch any input/output terminals of inverter with bare hands. Risk of electrical hazard. |
| |  Caution | <ul style="list-style-type: none"> ◆ If auto tuning is required, be careful of personal injury when motor is running. Risk of accident. ◆ Do not change the defaults of parameters. Risk of device damage. |
| During Operation |  Danger | <ul style="list-style-type: none"> ◆ Non-professionals shall not detect signals during operation. Risk of personal injury or device damage. ◆ Do not touch the fan or the discharging resistor to check the temperature. Failure to comply will result in personal burnt. |
| |  Caution | <ul style="list-style-type: none"> ◆ Prevent any foreign items from being left in the devices during operation. Risk of device damage. ◆ Do not control start/stop of inverter by ON/OFF of contactor. Risk of device damage. |
| Maintenance |  Danger | <ul style="list-style-type: none"> ◆ Maintenance and inspection can only be performed by professionals. Risk of personal injury. ◆ Maintain and inspect devices after power is off. Risk of electric hazard. ◆ Repair or maintain the AC drive only ten minutes after the AC drive is powered off. This allows for the residual voltage in the capacitor to discharge to a safe value. Failure to comply will result in personal injury. ◆ All pluggable components can be inserted or pulled out only when power has been turned off. ◆ Set and check the parameters again after the AC drive is replaced. |

1.2 Precautions

1.2.1 Motor Insulation Inspection

When the motor is used for the first time or when the motor is reused after being kept, or when periodical inspection is performed, insulation inspection shall be conducted with motor so as to avoid damaging the inverter because of the insulation failure of the motor windings. The motor wires must be disconnected from the inverter during the insulation inspection. It is recommended to use the 500V mega meter, and the insulating resistance measured shall be 5MΩ at least.

1.2.2 Motor Thermal Protection

If the motor rating does not match that of the inverter, especially when the rated power of the inverter is higher than that of the motor, adjust motor protection parameters in the inverter or install thermal relay to protect motor.

1.2.3 Operating with the Frequency Higher than Grid Power Frequency

Output frequency of FR600 is 0.00Hz~600.00Hz. If FR600 is required to operate above 50.00Hz, please take the endurance of mechanical devices into consideration.

1.2.4 Mechanical Vibrations

Inverter may encounter mechanical resonance point of the load device at certain output frequencies which can be avoided by setting the skip frequency parameters of the inverter.

1.2.5 Motor Heat and Noise

Since output voltage of inverter is PWM wave and contains a certain amount of harmonics, so that the temperature, noise and vibration of the motor will be higher than those when the inverter runs at grid power frequency.

1.2.6 Voltage-sensitive device or capacitor on output side of the AC drive

Do not install the capacitor for improving power factor or lightning protection voltage-sensitive resistor on the output side of the AC drive because the output of the AC drive is PWM wave. Otherwise, the AC drive may suffer transient overcurrent or even be damaged.

1.2.7 Contactor at the I/O terminal of the AC drive

When a contactor is installed between the input side of the AC drive and the power supply, the AC drive must not be started or stopped by switching the contactor on or off. If the AC drive has to be operated by the contactor, ensure that the time interval between switching is at least one hour since frequent charge and discharge will shorten the service life of the capacitor inside the AC drive. When a contactor is installed between the output side of the AC drive and the motor, do not turn off the contactor when the AC drive is active. Otherwise, modules inside the AC drive may be damaged.

1.2.8 Applied with the Rated Voltage

Apply FR600 with the rated voltage. Failure to comply will damage inverter. If required, take a transformer to boost or step-down voltage.

1.2.9 Do Not Apply a 3-Phase Input Inverter to 2-Phase Input Applications

Do not apply a 3-phase input FR inverter to 2-phase input applications. Otherwise, it will result in faults or damage inverter.

1.2.10 Lightning Protection

FR600 has integrated lightning over-current protection device which has certain self-protection capacity against the lightning. Additional protection devices have to be installed between inverter and power supply in the area where lightning occurs frequently.

1.2.11 Altitude De-rating

In places where the altitude is above 1000 m and the cooling effect reduces due to thin air, it is necessary to de-rate the AC drive. Contact FRECON for technical support.

1.2.12 some special usages

If wiring that is not described in this manual such as common DC bus is applied, contact the agent or FRECON for technical support.

1.2.13 Cautions for Inverter Disposal

The electrolytic capacitors on the main circuit and PCBA may explode when they are burnt. Emission of toxic gas may be generated when the plastic parts are burnt. Please dispose inverter as industrial wastes.

1.2.14 Adaptable Motor

The standard adaptable motor is adaptable four-pole squirrel-cage asynchronous induction motor or PMSM. For other types of motor, select a proper AC drive according to the rated motor current.

The cooling fan and rotor shaft of non-variable-frequency motor are coaxial, which results in reduced cooling effect when the rotational speed declines. If variable speed is required, add a more powerful fan or replace it with variable-frequency motor in applications where the motor overheats easily.

The standard parameters of the adaptable motor have been configured inside the AC drive. It is still necessary to perform motor auto-tuning or modify the default values based on actual conditions. Otherwise, the running result and protection performance will be affected.

The AC drive may alarm or even be damaged when short-circuit exists on cables or inside the motor. Therefore, perform insulation short-circuit test when the motor and cables are newly installed or during routine maintenance. During the test, make sure that the AC drive is disconnected from the tested parts.

Chapter 2 Product Information

2.1 Nameplate information

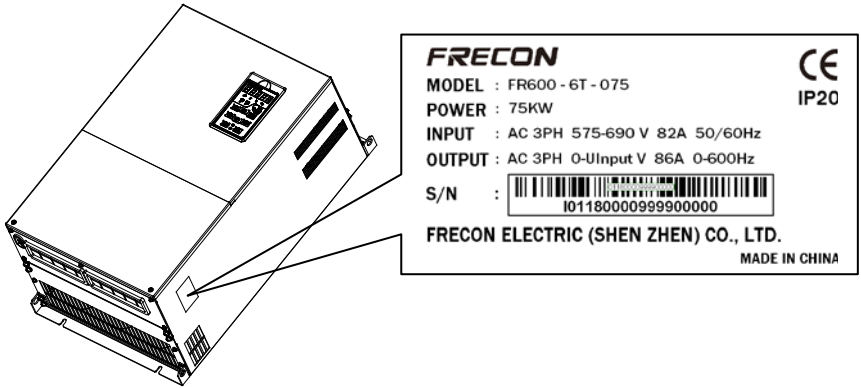

Fig.2-1 Nameplate information

Model Explanation

Model show on product nameplate contains information below

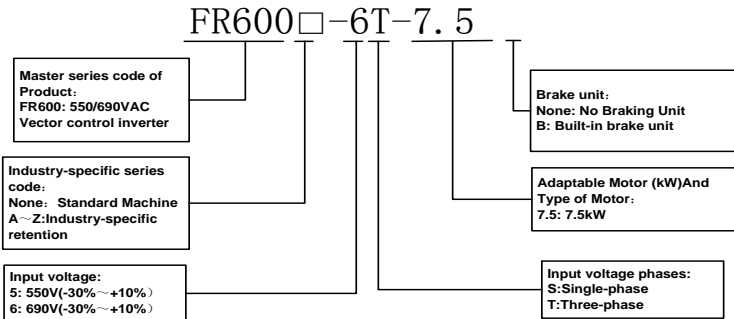

Fig.2-2 Model Explanation

2.2 Information of FR600 Product Model

Table 2-1 FR600 Product model and technical data

| Model No | Power capacity KVA | Rated Input current A | Rated output current A | Applicable motor kW HP | |
|---|-----------------------|-----------------------------|------------------------------|---------------------------|-----|
| 3-Phase: 550V, 50/60Hz Range: -30%~+10% | | | | | |
| FR600-5T-4.0 | 7.5 | 8 | 7.6 | 3.7、4 | 5 |
| FR600-5T-5.5 | 12 | 12 | 11 | 5.5 | 7.5 |
| FR600-5T-7.5 | 15 | 16 | 14.5 | 7.5 | 10 |
| FR600-5T-011 | 20 | 21 | 20 | 11 | 15 |
| FR600-5T-015 | 28 | 30 | 28 | 15 | 20 |
| FR600-5T-018 | 35 | 37 | 35 | 18.5 | 25 |
| FR600-5T-022 | 40 | 42 | 40 | 22 | 30 |
| FR600-5T-030 | 52 | 55 | 52 | 30 | 40 |
| FR600-5T-037 | 64 | 68 | 65 | 37 | 50 |
| FR600-5T-045 | 77 | 82 | 77 | 45 | 60 |
| FR600-5T-055 | 97 | 103 | 98 | 55 | 70 |
| FR600-5T-075 | 125 | 130 | 124 | 75 | 100 |
| FR600-5T-090 | 148 | 157 | 150 | 90 | 125 |
| FR600-5T-110 | 178 | 189 | 180 | 110 | 150 |
| FR600-5T-132 | 217 | 231 | 220 | 132 | 175 |
| FR600-5T-160 | 257 | 273 | 260 | 160 | 210 |
| FR600-5T-185 | 297 | 315 | 300 | 185 | 250 |
| FR600-5T-200 | 326 | 346 | 330 | 200 | 260 |
| FR600-5T-220 | 356 | 378 | 360 | 220 | 300 |
| FR600-5T-250 | 410 | 435 | 414 | 250 | 330 |
| FR600-5T-280 | 452 | 480 | 458 | 280 | 370 |
| FR600-5T-315 | 505 | 535 | 510 | 315 | 420 |
| FR600-5T-355 | 565 | 600 | 573 | 355 | 470 |
| FR600-5T-400 | 632 | 670 | 646 | 400 | 530 |
| 3-Phase: 690V, 50/60Hz Range: -30%~+10% | | | | | |
| FR600-6T-015 | 27 | 23 | 20 | 15 | 20 |
| FR600-6T-018 | 35 | 30.0 | 25 | 18.5 | 25 |
| FR600-6T-022 | 37 | 35.0 | 28 | 22 | 30 |
| FR600-6T-030 | 43 | 40.0 | 35 | 30 | 40 |
| FR600-6T-037 | 51 | 47.0 | 45 | 37 | 50 |
| FR600-6T-045 | 65 | 52.0 | 52 | 45 | 60 |
| FR600-6T-055 | 80 | 67.0 | 65 | 55 | 70 |
| FR600-6T-075 | 93 | 82.0 | 86 | 75 | 100 |
| FR600-6T-090 | 123 | 96.0 | 98 | 90 | 125 |
| FR600-6T-110 | 147 | 120.0 | 124 | 110 | 150 |
| FR600-6T-132 | 166 | 145.0 | 150 | 132 | 175 |
| FR600-6T-160 | 229 | 175.0 | 180 | 160 | 210 |
| FR600-6T-185 | 236 | 190.0 | 200 | 185 | 250 |
| FR600-6T-200 | 258 | 210.0 | 220 | 200 | 260 |
| FR600-6T-220 | 286 | 235.0 | 245 | 220 | 300 |
| FR600-6T-250 | 316 | 255.0 | 270 | 250 | 330 |
| FR600-6T-280 | 346 | 290.0 | 300 | 280 | 370 |
| FR600-6T-315 | 367 | 335.0 | 350 | 315 | 420 |
| FR600-6T-355 | 454 | 370.0 | 390 | 355 | 470 |
| FR600-6T-400 | 488 | 415.0 | 430 | 400 | 530 |
| FR600-6T-450 | 559 | 460 | 480 | 450 | 600 |
| FR600-6T-500 | 645 | 520 | 540 | 500 | 660 |
| FR600-6T-560 | 660 | 580 | 600 | 560 | 750 |

| | | | | | |
|--------------|-----|-----|-----|-----|-----|
| FR600-6T-630 | 812 | 655 | 680 | 630 | 840 |
|--------------|-----|-----|-----|-----|-----|

2.3 Technical Features of FR600

Table 2-2 Technical features of FR600

| Project | | Specifications |
|-------------------------|-------------------------------------|---|
| Power input | Rated input voltage (V) | 3-Phase: 550V, (-30%~+10%) 3-Phase: 690V, (-30%~+10%) |
| | Rated input current (A) | See table 2-1 |
| | Rated input frequency (Hz) | 50Hz/60Hz, tolerance±5% |
| Power output | Applicable motor (kW) | See table 2-1 |
| | Rated output current (A) | See table 2-1 |
| | The maximum output voltage (V) | 0~rated input voltage, error<±3% |
| | The maximum output frequency (Hz) | 0.00~600.00 Hz,unit0.01Hz |
| Control characteristics | V/f patterns | V/f control Sensor-less vector control 1 Sensor-less vector control 2 |
| | Speed range | 1:50 (V/f control) 1:100 (sensor-less vector control 1) 1:200 (sensor-less vector control 2) |
| | Speed accuracy | ±0.5% (V/f control) ±0.2% (sensor-less vector control 1 & 2) |
| | Speed fluctuation | ±0.3% (sensor-less vector control 1 & 2) |
| | Torque response | < 10ms (sensor-less vector control 1 & 2) |
| | Starting torque | 0.5Hz: 180% (V/f control, sensor-less vector control 1) 0.25Hz: 180% (sensor-less vector control 2) |
| Basic functions | Carrier frequency | 0.7kHz~16kHz |
| | Overload capability | G Model: 150% Rated Current 60s,180% Rated Current 10s,200% Rated Current 1s. |
| | Torque boost | Automatic torque boost; Manual torque boost 0.1%~30.0% |
| | V/F Curve | Three ways: Three ways: straight; multi-point type; N Th-type V / F curve (1.2 Th -type、 1.4 Th -type、 1.6 Th -type、 1.8 Th -type、 2 Th -type) |
| | Acceleration and deceleration Curve | Line or curve acceleration and deceleration mode. Four kinds of acceleration and deceleration time, Ramp Time Range :0.0~6000.0s |
| | DC brake | DC brake start frequency: 0.00~600.00Hz DC brake time:0.0s~10.0s DC brake current: 0.0%~150.0% |

| | | |
|----------------------|---|--|
| Basic functions | Jog brake | Jog frequency range: 0.00Hz~50.00Hz. Jog deceleration time: 0.0s~6000.0s. |
| | Simple PLC、 Multi-speed | Through the built-in PLC or control terminal to achieve up to 16 speed running |
| | Built-in PID | Facilitate the realization of process control loop control system |
| | Automatic voltage adjustment (AVR) | When the grid voltage changes, can automatically maintain a constant output voltage |
| | Fast current limit function | Minimize over current fault protection inverter running |
| | Over voltage Over current | System automatically limits of current and voltage during operation to prevent frequent |
| Run | Command source | Given the control panel, control terminal, serial communication port given. |
| | Frequency given | 9 frequency sources: digital setting, keyboard potentiometer setting, analog Voltage, given analog current reference pulse is given, the serial port is given, multi-speed given, PLC is given, the process PI D reference. There are several ways to switch |
| | Input terminal | 7 Switch input terminals, one way to make high-speed pulse input. 3-channel analog inputs, including 2-way 0~10V / 0~20mA voltage and current options, a way to support -10~+10 V input |
| | output terminal | 2-way switch output terminal, which supports a maximum road speed 100kHz pulse output. 2 relay output terminals. 2 analog output terminal, and optional voltage and current. |
| Featured functions | <p>Parameter copy、 parameter backup、 flexible parameter displayed & hidden. Common DC bus (Contains below 30 KW) .</p> <p>Various master & auxiliary command and switchover.</p> <p>Reliable speed search started.</p> <p>A variety of Accel / Decel curves programmable.</p> <p>Timing control、 fixed length control、 count function.</p> <p>Three faults recorded.</p> <p>Over excitation brake、 overvoltage stall protection programmable、 under voltage stall protection programmable、 restart upon power loss.</p> <p>Four kinds of Accel/Decel time.</p> <p>Motor thermal protection.</p> <p>Flexible fan control.</p> <p>Process PID control、 simple PLC、 16-step speed control programmable.</p> <p>Wobble frequency control.</p> <p>Multi-functional key programmable、 field-weakening control.</p> <p>High-precision torque control、 V/f separated control、 torque control at sensor-less vector control.</p> | |
| Protection function | Provide fault protection dozen: Overcurrent、 Overvoltage、 Undervoltage、 Overtemperature、 Overload Etc Protection. | |
| Display and keyboard | LED Display | Display Parameters |
| | Key lock and function selection | Realize some or all of the keys locked, scope definition section keys to prevent misuse |
| | Run and stop | In the run or stop can be set to monitor U00 group four |

| | | |
|-------------|------------------------|---|
| | monitoring information | objects were. |
| Environment | Place of operation | Indoors, no direct sunlight, free from dust, corrosive gases, flammable gases, oil mist, water vapor, water drop and salt, etc. |
| | Altitude | 0~2000m De-rate 1% for every 100m when the altitude is above 1000 meters |
| | Ambient temperature | -10℃~40℃ |
| | Relative humidity | 5~95%, no condensation |
| | Vibration | Less than 5.9m/s ² (0.6g) |
| | Storage temperature | -20℃~+70℃ |
| Others | Efficiency | Rated power≥93% |
| | Installation | Wall-mounted or Flange mounting |
| | IP grade | IP20 |
| | Cooling method | Fan cooled |

2.4 Parts Drawing

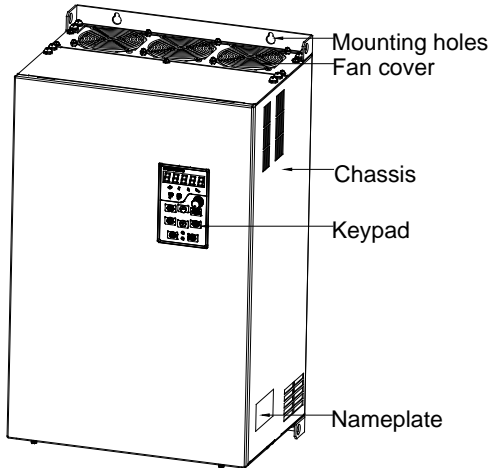

Fig 2-4 Sheetmetal Structure Outline

2.5 Configuration, Mounting Dimensions and Weight

a: FR600-6T-4.0~630kW Dimensions and wall mounting dimensions

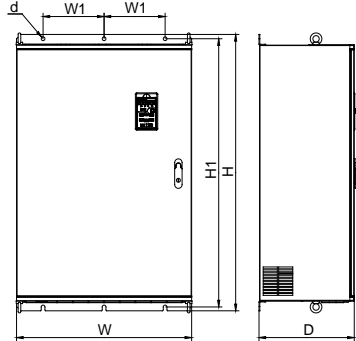
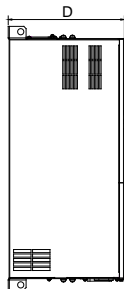
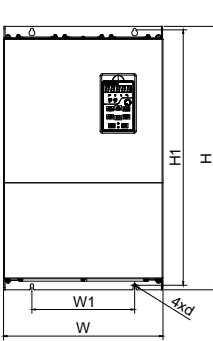

Fig 2-6 4.0~200kW wall mounting diagram (1)

Fig 2-7 220~630kW wall mounting diagram (2)

Table 2-3 Configuration, mounting dimensions and weight

| Model NO. | External and installation dimensions (mm) | | | | | | Weight (Kg) |
|---|---|-----|------|------|-----|------------------------|-------------|
| | W | W1 | H | H1 | D | Mounting Hole Diameter | |
| 3-Phase: 550V, 50/60Hz Range: -30%~+10% | | | | | | | |
| FR600-5T-4.0 | 198 | 183 | 300 | 287 | 195 | 5.5 | 6.2 |
| FR600-5T-5.5 | | | | | | | |
| FR600-5T-7.5 | | | | | | | |
| FR600-5T-011 | | | | | | | |
| FR600-5T-015 | | | | | | | |
| FR600-5T-018 | 270 | 130 | 545 | 527 | 270 | 7 | |
| FR600-5T-022 | | | | | | | |
| FR600-5T-030 | | | | | | | |
| FR600-5T-037 | | | | | | | |
| FR600-5T-045 | | | | | | | |
| FR600-5T-055 | 355 | 230 | 620 | 602 | 290 | 7 | |
| FR600-5T-075 | | | | | | | |
| FR600-5T-090 | | | | | | | |
| FR600-5T-110 | | | | | | | |
| FR600-5T-132 | | | | | | | |
| FR600-5T-160 | 430 | 320 | 825 | 798 | 305 | 12 | |
| FR600-5T-185 | | | | | | | |
| FR600-5T-200 | | | | | | | |
| FR600-5T-220 | | | | | | | |
| FR600-5T-250 | | | | | | | |
| FR600-5T-280 | 660 | 230 | 1030 | 1000 | 369 | 14 | |
| FR600-5T-315 | | | | | | | |
| FR600-5T-355 | | | | | | | |
| FR600-5T-400 | | | | | | | |
| FR600-5T-400 | | | | | | | |
| 3-Phase: 690V, 50/60Hz Range: -30%~+10% | | | | | | | |
| FR600-6T-015 | 270 | 130 | 545 | 527 | 270 | 7 | |
| FR600-6T-018 | | | | | | | |
| FR600-6T-022 | | | | | | | |
| FR600-6T-030 | | | | | | | |

| | | | | | | | |
|--------------|-----|-----|------|------|-----|----|--|
| FR600-6T-037 | | | | | | | |
| FR600-6T-045 | | | | | | | |
| FR600-6T-055 | 357 | 230 | 620 | 602 | 290 | 7 | |
| FR600-6T-075 | | | | | | | |
| FR600-6T-090 | | | | | | | |
| FR600-6T-110 | | | | | | | |
| FR600-6T-132 | 430 | 320 | 825 | 798 | 305 | 12 | |
| FR600-6T-160 | | | | | | | |
| FR600-6T-185 | | | | | | | |
| FR600-6T-200 | | | | | | | |
| FR600-6T-220 | 660 | 230 | 1030 | 1000 | 369 | 14 | |
| FR600-6T-250 | | | | | | | |
| FR600-6T-280 | | | | | | | |
| FR600-6T-315 | | | | | | | |
| FR600-6T-355 | | | | | | | |
| FR600-6T-400 | | | | | | | |
| FR600-6T-450 | 810 | 300 | 1167 | 1137 | 460 | 14 | |
| FR600-6T-500 | | | | | | | |
| FR600-6T-560 | | | | | | | |
| FR600-6T-630 | | | | | | | |

* note: 450 ~ 630 kw dc reactor can be installed in a gutter or rack, if vertical installation, need to purchase the base (dc reactor can be installed in the base), base height is 452 mm.

2.6 Flange mounting dimensions

4.0~200kW Flange mounting dimensions

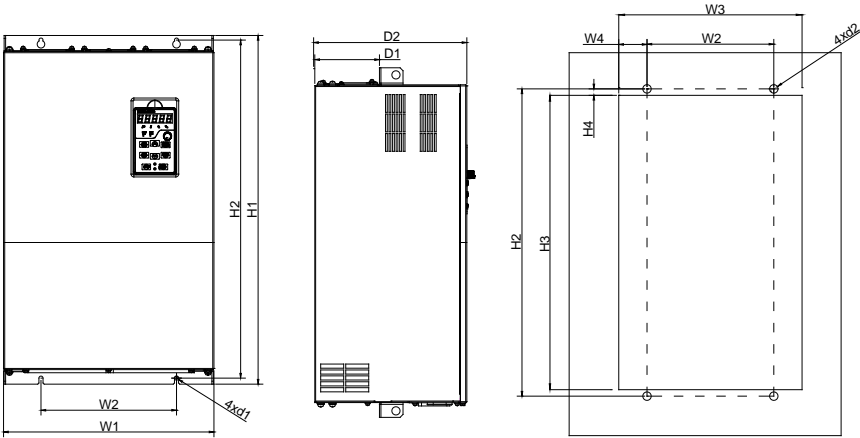

Fig 2-9 4.0~200kW Flange mounting installation diagram

Table 2-4 Flange mounting dimensions table

| Model.NO | External and installation dimensions (mm) | | | | | | | | | | | |
|---|---|-----|-----|------|-----|-----|-----|-----|-----|-----|----|----|
| | W1 | W2 | W3 | W4 | H1 | H2 | H3 | H4 | D1 | D2 | d1 | d2 |
| 3-Phase: 550V, 50/60Hz Range: -30%~+10% | | | | | | | | | | | | |
| FR600-5T-4.0 | 198 | 160 | 199 | 17 | 330 | 313 | 302 | 5.5 | 185 | 91 | 6 | 6 |
| FR600-5T-5.5 | | | | | | | | | | | | |
| FR600-5T-7.5 | | | | | | | | | | | | |
| FR600-5T-011 | | | | | | | | | | | | |
| FR600-5T-015 | | | | | | | | | | | | |
| FR600-5T-018 | 270 | 130 | 276 | 73 | 547 | 529 | 510 | 10 | 110 | 268 | 7 | 7 |
| FR600-5T-022 | 357 | 230 | 361 | 65.5 | 622 | 604 | 585 | 10 | 120 | 288 | 7 | 7 |
| FR600-5T-030 | | | | | | | | | | | | |
| FR600-5T-037 | | | | | | | | | | | | |
| FR600-5T-045 | | | | | | | | | | | | |
| FR600-5T-055 | | | | | | | | | | | | |
| FR600-5T-075 | 430 | 320 | 320 | 58 | 827 | 800 | 771 | 14 | 169 | 303 | 12 | 12 |
| FR600-5T-090 | | | | | | | | | | | | |
| FR600-5T-110 | | | | | | | | | | | | |
| FR600-5T-110 | | | | | | | | | | | | |
| FR600-5T-132 | | | | | | | | | | | | |
| 3-Phase: 690V, 50/60Hz Range: -30%~+10% | | | | | | | | | | | | |
| FR600-6T-015 | 270 | 130 | 276 | 73 | 547 | 529 | 510 | 10 | 110 | 268 | 7 | 7 |
| FR600-6T-018 | | | | | | | | | | | | |
| FR600-6T-022 | | | | | | | | | | | | |
| FR600-6T-030 | | | | | | | | | | | | |
| FR600-6T-037 | | | | | | | | | | | | |
| FR600-6T-045 | 357 | 230 | 361 | 65.5 | 622 | 604 | 585 | 10 | 120 | 288 | 7 | 7 |
| FR600-6T-055 | | | | | | | | | | | | |
| FR600-6T-075 | | | | | | | | | | | | |
| FR600-6T-090 | | | | | | | | | | | | |
| FR600-6T-110 | | | | | | | | | | | | |
| FR600-6T-110 | | | | | | | | | | | | |
| FR600-6T-132 | | | | | | | | | | | | |
| FR600-6T-160 | | | | | | | | | | | | |
| FR600-6T-185 | | | | | | | | | | | | |
| FR600-6T-200 | | | | | | | | | | | | |

2.7 External Dimensions of Keypad

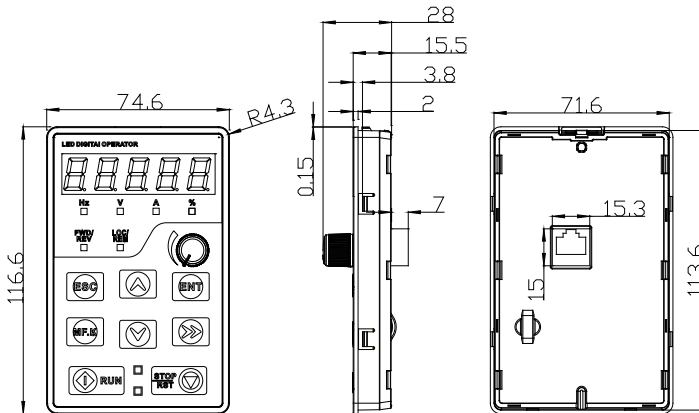
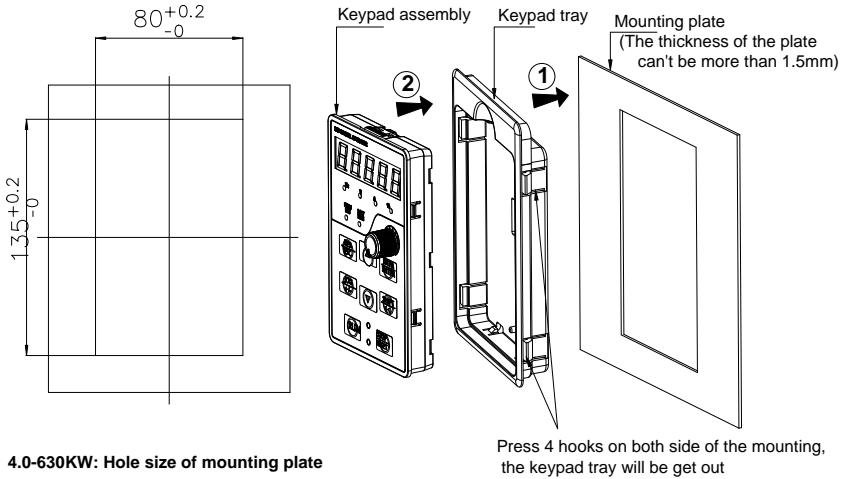

Fig 2-10 4.0~630KW Keyboard size diagram

External keyboard installation instruction:

1. first install the panel according to inverter's power range corresponding to the size of hole as shown on scheme 2-11, After that insert keyboard pad into the mounting panel and then insert the keyboard module into the keypad tray. (Before removing the keyboard pad, first remove the keyboard, then remove as shown in the scheme)



4.0-630KW: Hole size of mounting plate

Fig 2-11 4.0~630KW External keyboard installation hole size diagram

Chapter 3 Installation and Wiring

3.1 Installation Environment

- 1) Ambient temperature in the range of -10°C to 50°C .
- 2) Drive should be installed on surface of flame retardant object, with adequate surrounding space for heat dissipation.
- 3) Installation should be performed where vibration is less than 5.9m/s^2 (0.6g).
- 4) Avoid from moisture and direct sunlight.
- 5) Protect the cooling fan by avoiding oil, dust and metal particles;
- 6) Do not expose to an atmosphere with flammable gases, corrosive gases, explosive gases or other harmful gases.
- 7) Prevent drilling residues, wire ends and screws falling into drive.
- 8) Ventilation part of the drive should be installed outside from harsh environment (e.g. Textile facilities with fiber particles and chemical facilities filled with corrosive gases or Loaded dust cover).

3.2 Installation Direction, Space and Cooling

A fan is integrated in FR600 for forced air cooling. FR600 has to be installed vertically for the purpose of good cooling circulation. Sufficient spaces have to be left between FR600 and its peripheral objects. Multi- FR600 can be installed in parallel horizontally and vertically. See followings for specific space requirement, heat dissipating capacity and mass airflow.

FR600 series inverter installation of the following three:

Wall mounting: (suitable for 630KW (inclusive)) .

Wall-mounted: (suitable for 200KW (inclusive)) .

Floor installation: (Suitable for 430-630kW inverter) .

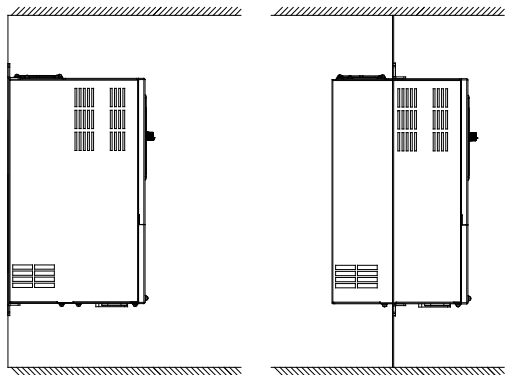

The wall mount

Through wall-mounted

Fig 3-1 Installation methods

3.2.1 Single installation

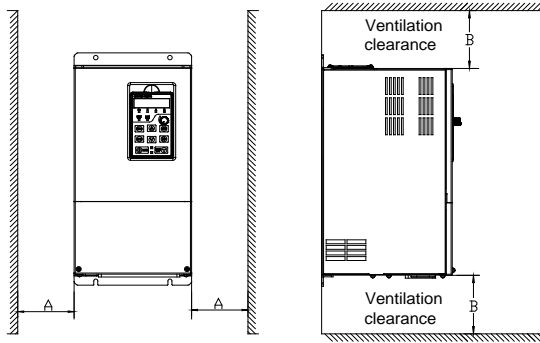

Fig.3-2 Single inverter mounting orientation and space requirements

3.2.2 Multiple installations

a. Multiple parallel installations

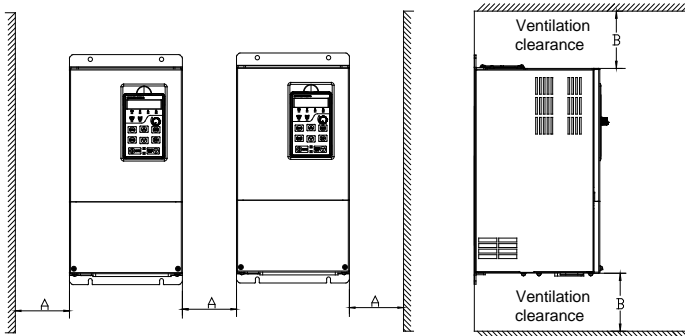

Fig.3-3 multiple inverters installed direction and space requirements

b. Multiple Upper and lower installations

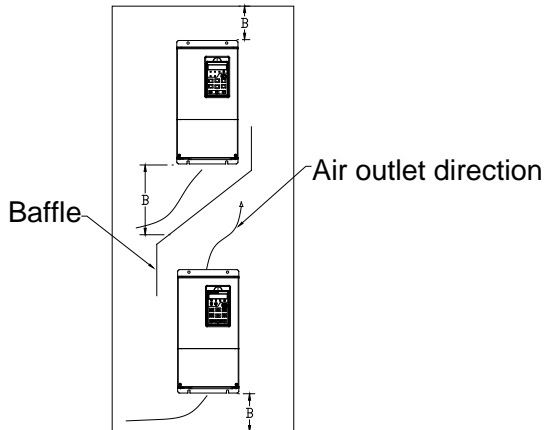

Fig.3-4 Multiple inverters installed Upper and lower mounting direction and space

Table 3-1 Requirement of minimum mounting clearances

| Drive model | Mounting clearances (mm) | |
|----------------|--------------------------|------|
| | A | B |
| 4.0~37kW | ≥50 | ≥200 |
| 45kW and above | ≥150 | ≥300 |

3.3 Fixed manner

a. Wall installation

Wall mounting dimensions refer to Chapter II (table 2-3), As shown in Fig drilling four holes in the mounting surface, Put the inverter against the panel and mate 4 holes, and then tighten screws in the 4 holes tighten any of the 2 screws in diagonal position, tighten 4 holes with screws for strengthened installation.

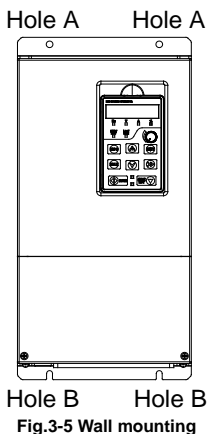

Fig.3-5 Wall mounting

b. Wall mounting

5.5~200kW Install the drive mounting bracket as shown in FIG 3-6. Wall installation dimensions refer to Chapter II (table 2-4), As shown in Fig drilling four holes in the mounting surface, Put the inverter against the panel and mate 4 holes, and then tighten screws in the 4 holes tighten any of the 2 screws in diagonal position, tighten 4 holes with screws for strengthened installation.

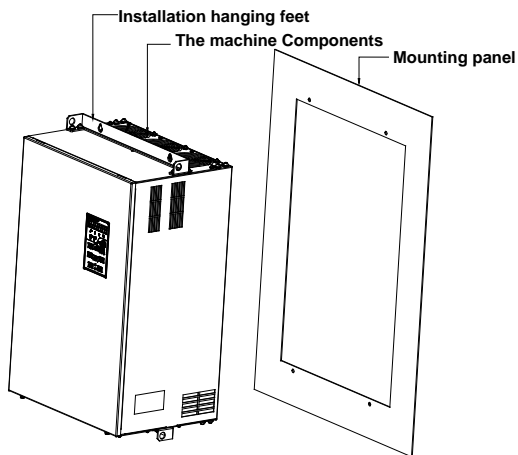

Fig.3-6 15.5~200kW Wall installation



Do not take the sunken screws as shown in the picture. Otherwise, inverter may be damaged



Take screws combined with springs and plain gaskets to Install inverter.

3.4 Wiring way

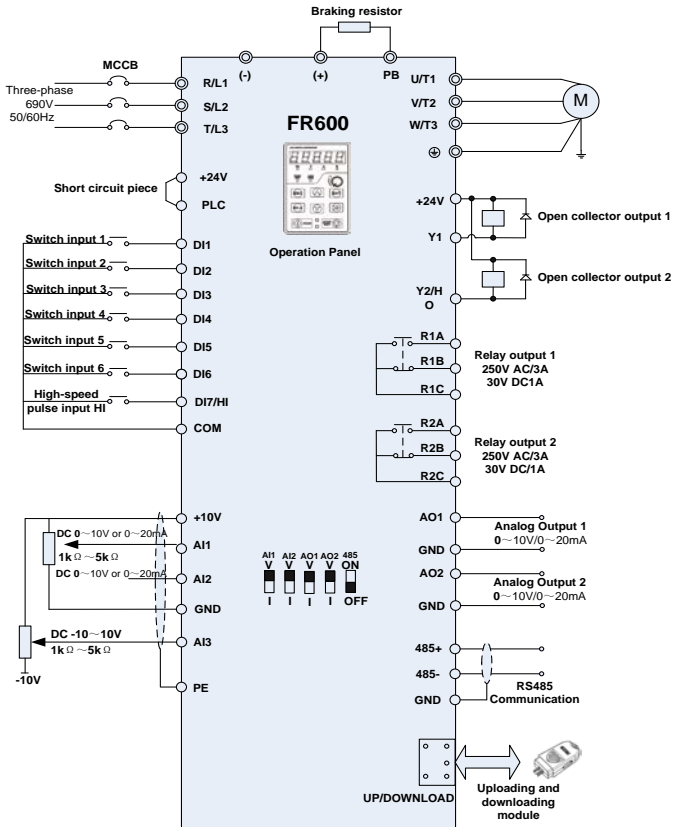

Fig.3-10 FR600 Inverter wiring diagram

Remarks:

- 1) ⊙ refers to main circuit terminals, ○ refers to control circuit terminals.
- 2) User selects braking resistor based on real needs. Please refer to the braking resistor Selection Guide.
- 3) Signal cable and power cable should be separated. Try to cross control cable and

power cable in 90° if needed. The best selection of analog signal lines shielded twisted pair, Power cables use shielded three-core cable(The specifications of the motor cable than ordinary freshman profile)or Comply with manual drive.

3.5 Terminal Configuration

3.5.1 Main Circuit Terminals

a: 4.0~18.5kW Main Circuit Terminals

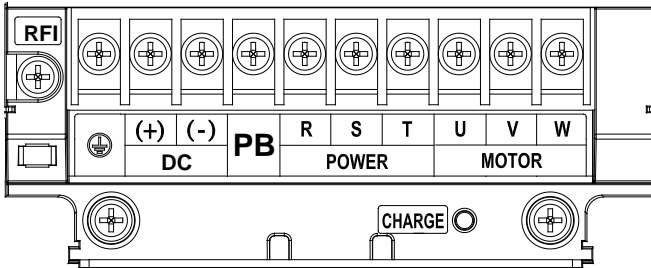

Fig.3-13 4.0~18.5kW Schematic of main circuit terminals

b: 22~90kW Main Circuit Terminals

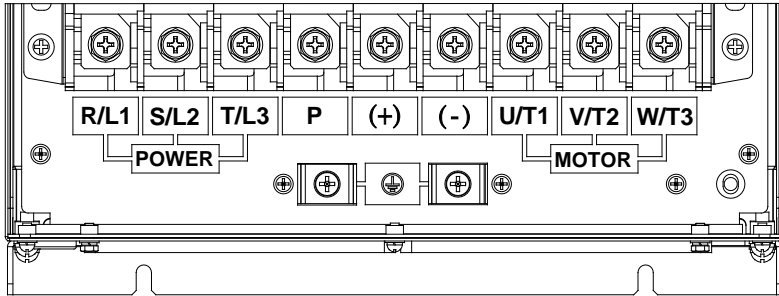

Fig.3-14 22~90kW Schematic of main circuit terminals

c:110~630kW Main Circuit Terminals

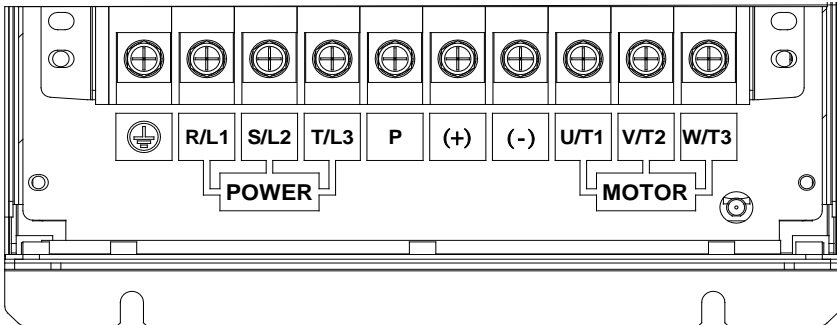



Fig.3-15 110~630kW Schematic of main circuit terminals

Table 3-6 main circuit terminal functions

| | |
|---|---|
| Terminal marks | Designation and function of terminals. |
| R/L1、S/L2、T/L3 | AC power input terminals for connecting to 3-phase 690V AC power supply. |
| U/T1、V/T2、W/T3 | AC output terminals of inverter for connecting to 3-phase induction motor. |
| (+)、(-) | Positive and negative terminals of internal DC bus. |
| PB | Positive and negative terminals of internal DC bus. Connecting terminals of braking resistor. One end connected to + and the other to PB. |
|  | Grounding terminal. |

Remarks: No phase sequence requirements on wiring of the input side of inverter. Wiring Precautions:

1) Power input terminals R/L1、S/L2、T/L3

◆ The cable connection on the input side of the AC drive has no phase sequence requirement.

2) DC bus (+)、(-)

◆ Terminals (+) and (-) of DC bus have residual voltage after the AC drive is switched off. After indicator CHARGE goes off, wait at least 10 minutes before touching the equipment. Otherwise, you may get electric shock.

◆ Do not connect the braking resistor directly to the DC bus. Otherwise, it may damage the AC drive and even cause fire.

3) Braking resistor connection terminals (+)、PB

◆ The cable length of the braking resistor shall be less than 5 m. Otherwise, it may damage the AC drive.

4) AC drive output terminals U/T1、V/T2、W/T3

◆ The capacitor or surge absorber cannot be connected to the output side of the AC drive. Otherwise, it may cause frequent AC drive fault or even damage the AC drive.

If the motor cable is too long, electrical resonance will be generated due to the impact of distributed capacitance. This will damage the motor insulation or generate higher leakage current, causing the AC drive to trip in overcurrent protection. If the motor cable is greater than 100 m long, an AC output reactor must be installed close to the AC drive.

5) Terminal  PE

◆ This terminal must be reliably connected to the main earthing conductor. Otherwise, it may cause electric shock, mal-function or even damage to the AC drive.

◆ Do not connect the earthing terminal to the neutral conductor of the power supply.

3.5.2 Control circuit terminals

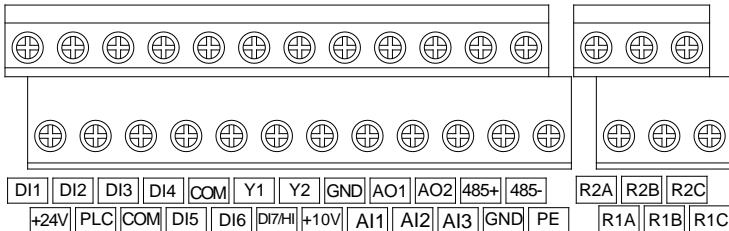



Fig.3-19 Control circuit terminals

Table 3-7 FR600 Description of control circuit terminals

| Type | Terminal | Name | Function Description |
|--------------|----------|-----------------------------|--|
| Power supply | +10V-GND | External +10 V power supply | Provide +10 V power supply to external unit. Generally, it provides power supply to external potentiometer with resistance |

| | | | |
|-------------------|------------|--|--|
| | | | range of 1–5 k Ω . Maximum output current: 10 mA |
| | +24V-COM | External +24V power supply Applying to Overvoltage Category II circuit | Provide +24 V power supply to external unit. Generally, it provides power supply to DI/DO terminals and external sensors. Maximum output current: 200 mA |
| | PLC | Input terminal of external power supply | Connect to +24 V by default. When DI1-DI7 need to be driven by external signal, PLC needs to be connected to external power supply and be disconnected from +24 V. |
| Analog input | AI1-GND | Analog input 1 | Input voltage range: DC 0~10V/0~20mA, decided by toggle switches AI1、AI2 on the control board Impedance: 250 k Ω (voltage input), 250 Ω (current input) |
| | AI2-GND | Analog input 2 | |
| | AI3-GND | Analog input 3 | Input Voltage Range: DC -10~+10V Input impedance: 250k Ω |
| Switch input | DI1- COM | Switch input terminals 1 | Maximum input frequency: 200Hz Impedance: 2.4k Ω Voltage range for level input: 9V~30V |
| | DI2- COM | Switch input terminals 2 | |
| | DI3- COM | Switch input terminals 3 | |
| | DI4- COM | Switch input terminals 4 | |
| | DI5- COM | Switch input terminals 5 | |
| | DI6- COM | Switch input terminals 6 | |
| | DI7/HI-COM | Switch input terminals 7 OR High-speed pulse input | Besides features of DI1–DI6, it can be used for high-speed pulse input. Maximum input frequency: 100 kHz |
| Analog output | AO1-GND | Analog output terminal 1 | Output voltage range: DC 0~10V/0~20mA, decided by toggle switches AO1、AO2 on the control board Impedance requirements \geq 10k Ω |
| | AO2-GND | Analog output terminal 2 | |
| Switch output | Y1-COM | Open collector output 1 | Voltage range: 0~24V Current range: 0~50mA |
| | Y2/HO-COM | Open collector output 2 OR High-speed pulse output | Besides features of Y1, it can be used for High-speed pulse output channels. The maximum output frequency: 100kHz |
| Relay output | R1A-R1C | Normally open terminal | Contact driving capacity: AC250V, 3A, COS ϕ =0.4. DC 30V, 1A |
| | R1B-R1C | Normally closed terminal | |
| | R2A-R2C | Normally open terminal | |
| | R2B-R2C | Normally closed terminal | |
| 485 Communication | 485+-485- | 485 Communication Terminals | Rate: 4800/9600/19200/38400/57600/ 115200bps |

| | | | |
|------------------------|---|--|---|
| | GND | 485 Communication shielded ground | Termination resistor is set by the toggle switch on the control panel RS485 |
| Shield | PE | Shield Ground | Ground terminal for shield |
| Auxiliary Interface |  | External operation panel interface | Use standard network cable Maximum cable distance: 50m |
| | UP/DOWNLOAD | Parameter copy interface | |

Description of Wiring of Signal Terminals:

1) Description Use the analog input terminal

Weak analog voltage signals are easy to suffer external interference, and therefore the shielded cable must be used and the cable length must be less than 20 m, as shown in following figure. When the analog input signal to an external power supply, AI1 Terminal wiring as shown in Fig 3-12 (a) .When the input analog voltage signal is potentiometer, AI1 Terminal wiring as shown in Fig 3-12 (b) ,AI2/AI3 Similar to AI1.

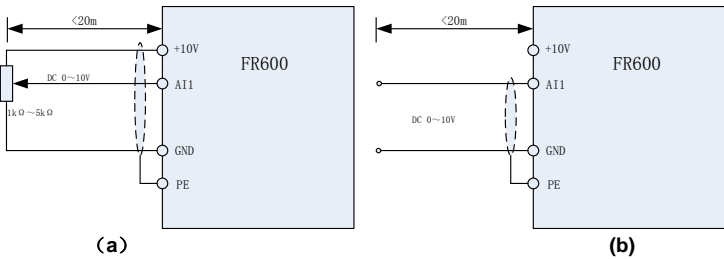

Fig.3-20 Analog input terminal wiring diagram

2) Instructions of Digital Input/output Terminals

Digital input & output signals cables should be as short as possible, shielded, and their shielded layers should be properly grounded close to the side of drive. The cables should not exceed 20m. When active drive is selected, take necessary filtering measures against power crosstalk, for which dry contact control is recommended.

Control cables shall be kept no less than 20cm away from main circuit and strong current lines (e.g. power lines, motor lines, relay lines and contactor lines) and should not be arranged in parallel with strong current lines. In case it is inevitable to intersect strong current line, vertical wiring is recommended to avoid drive faults as a result of noise. Operating instructions for switching value input terminal

A: Dry contact

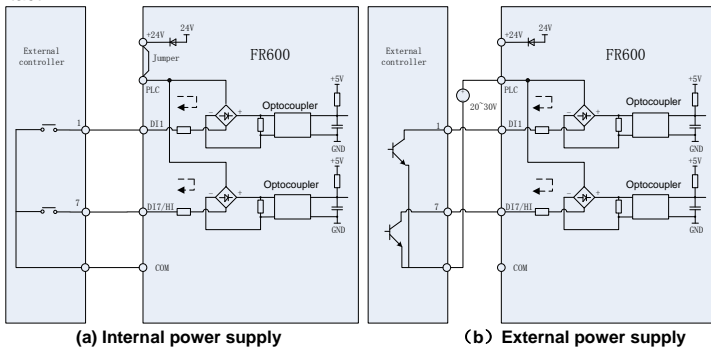

Fig.3-21 Dry contact

ATTENTION:

When external power supply is used, the jumper between +24V and PLC must be removed.

Otherwise, it may result in equipment damage

The voltage range of external power supply should be DC20~30V. Otherwise, normal operation could not be assured and/or result in equipment damage.

B: Open collector NPN connection

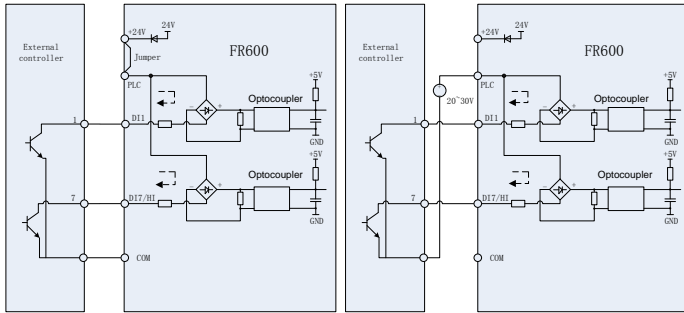

(a) Internal power supply

(b) External power supply

Fig.3-22 External power supply open collector NPN connection

ATTENTION:

When external power supply is utilized, the jumper between +24V and PLC must be removed. The voltage range of external power supply should be DC20~30V, otherwise normal operation could not be assured and/or hazard of equipment damage exists.

C: Open collector PNP connection

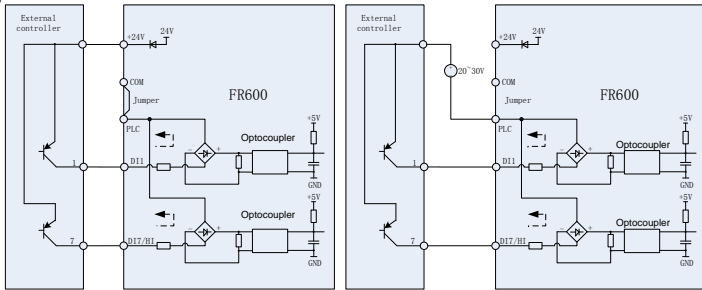

(a) Internal power supply

(b) External power supply

Fig.3-23 internal power supply open collector PNP connection

3) Instructions of digital output terminal

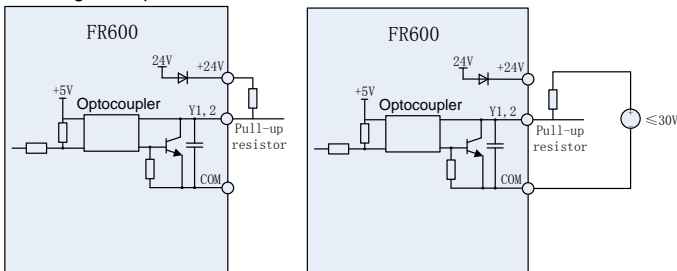

(a) Internal power supply

(b) External power supply

Fig.3-24 wiring when Y2 and HO output with pull-up resistors

ATTENTION:

When set to be pulse output, Y2/HO terminal shall output 0~100kHz pulse signal.

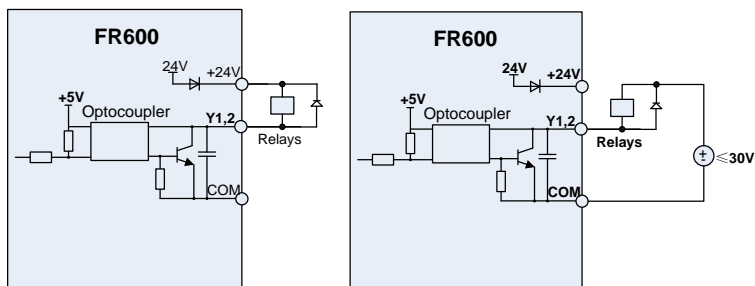

(a) Internal power supply
 (b) External power supply
Fig 3-25 mode of connection when the terminal drives relay

ATTENTION:

When relay coil voltage is lower than 24V, a resistor as voltage divider should be mounted between relay and output terminal, based on coil impedance.

4) Wiring instruction of relay output terminal

Control boards of FR600 series drives are provided with two programmable relay dry contact outputs. One relay contacts are R1A/R1B/R1C, whose R1A and R1C are normally open, while R1B and R1C are normally closed. See parameter F05.02 for details.

The others contacts are R2A /R2B/R2C, whose R2A and R2C are normally open, while R2B and R2C are normally closed. See parameter F05.03 for details.

ATTENTION:

In case inductive load (e.g. electromagnetic relay or contactor) is to be driven, a surge voltage absorbing circuit such as RC absorbing circuit (note that its leakage current shall be less than holding current of controlled contactor or relay), piezoresistor or fly-wheel diode etc. shall be mounted (be sure to pay close attention to polarity in case of DC electromagnetic circuit). Absorbing devices should be mounted close to the ends of relay or contactor.

5) Instruction of Signal Switch



| Terminal | Function | Factory default |
|----------|---|-------------------------|
| AI1 | I: current input (0~20mA); V: voltage input (0~10V) | 0~10V |
| AI2 | I: current input (0~20mA); V: voltage input (0~10V) | 0~10V |
| AO1 | I: current output (0~20mA); V: voltage output (0~10V) | 0~10V |
| AO2 | I: current output (0~20mA); V: voltage output (0~10V) | 0~10V |
| RS485 | Selection of 485 termination resistor; ON :120Ω termination resistor provided; OFF: no termination resistor | No termination resistor |

3.6 EMI Solutions

Due to its working principle, the drive will inevitably produce certain noise that may influence and disturb other equipment. Moreover, since the internal weak electric signal of drive is also susceptible to the interference of drive itself and other equipment, EMI problems shall be inevitable. In order to reduce or avoid the interference of drive to external environment and protect drive against interference from external environment, this section makes a brief description of noise abatement, ground handling, leakage current suppression and the application of power line filters.

3.6.1 Noise Abatement

When peripheral equipment and drive share the power supply of one system, noise from drive may be transmitted to other equipment in this system via power lines and result in misoperation and/or faults. In such a case, the following measures could be taken:

- 1) Mount input noise filter at input terminal of the drive;
- 2) Mount power supply filter at power input terminal of affected equipment;
- 3) Use isolation transformer to isolate the noise transmission path between other equipment and the drive.

As the wiring of peripheral equipment and drive constitutes a circuit, the unavoidable earthing leakage current of inverter will cause equipment misoperation and/or faults.

Disconnect the grounding connection of equipment may avoid this misoperation and/or faults

Sensitive equipment and signal lines shall be mounted as far away from drive as possible.

Signal lines should be provided with shielded layer and reliably grounded. Alternatively, signal cable could be put into metallic conduits between which the distance shall be no less than 20cm, and shall be kept as far away from drive and its peripheral devices, cables as possible. Never make signal lines in parallel with power lines or bundle them up.

Signal lines must orthogonally cross power lines if this cross inevitable.

Motor cables shall be placed in thick protective screen like more than 2mm-thick pipelines or buried cement groove, also, power lines can be put into metallic conduit and grounded well with shielded cables.

Use 4-core motor cables of which one is grounded at close side of the drive and the other side is connected to motor enclosure.

Input and output terminals of drive are respectively equipped with radio noise filter and linear noise filter. For example, ferrite common mode choke can restrain radiation noise of power lines.

3.6.2 Grounding

Recommended ground electrode is shown in the figure below:

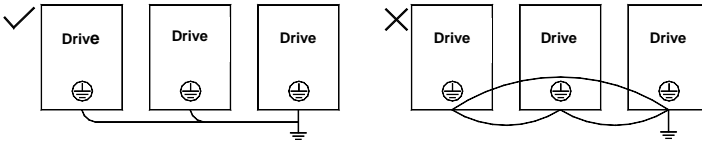

Fig 3-28 Inverter grounding diagram

Use to the fullest extent the maximum standard size of grounding cables to reduce the impedance of grounding system;

Grounding wires should be as short as possible;

Grounding point shall be as close to the drive as possible;

One wire of 4-core motor cables shall be grounded at the drive side and connected to grounding terminal of motor at the other side. Better effect will be achieved if motor and drive are provided with dedicated ground electrodes;

When grounding terminals of various parts of system are linked together, leakages current turns into a noise source that may influence other equipment in the system, thus, grounding terminals of the drive and other vulnerable equipment should be separated.

Grounding cable shall be kept away from inlet & output of noise-sensitive equipment.

3.6.3 Leakage Current Suppression

Leakage current passes through the line-to-line and ground distributed capacitors at input & output sides of drive, and its size is associated with the capacitance of distributed capacitor and the carrier frequency. Leakage current is classified into ground leakage current and line-to-line leakage current.

Ground leakage current not only circulates inside drive system, but may also influence other equipment via ground loop. Such a leakage current may result in malfunction of RCD and other equipment. The higher the carrier frequency of drive is, the bigger the ground leakage current would be. The longer the motor cables and the bigger the parasitic capacitances are, the bigger the ground leakage current would be. Therefore, the most immediate and effective method for suppression of ground leakage current is to reduce carrier frequency and minimize the length of motor cables.

The higher harmonics of line-to-line leakage current that pass through between cables at output side of drive will Accel the aging of cables and may bring about malfunction of other equipment. The higher the carrier frequency of drive is, the bigger the line-to-line leakage current would be. The longer the motor cables and the bigger the parasitic capacitances are, the bigger the line-to-line leakage current would be. Therefore, the most immediate and effective method for suppression of ground leakage current is to reduce carrier frequency and minimize the length of motor cable. Line-to-line leakage current can also be effectively suppressed by mounting additional output reactors.

3.6.4 Use of Power Supply Filter

Since AC drives may generate strong interference and are also sensitive to outside interference, power supply filters are recommended. Pay close attention to the following instructions during the use:

Enclosure of the filter needs to be reliably grounded;

Input lines of the filter shall be kept as far away from output lines as possible so as to avoid mutual coupling;

Filter shall be as close to the drive side as possible;

Filter and drive must be connected to the same common ground.

Chapter 4 Operation and display

4.1 Introduction of Keypad

As a human-machine interface, you can modify the parameters, monitor the working status and start or stop the inverter by operating the keypad. Its appearance and function area as shown in the following figure:













Fig.4-1 Keypad

4.1.1 Key and potentiometer Functions on keypad

There are 8 keys and a potentiometer on the keypad, whose functions are as shown in Table 4-1.



Table 4-1 Key functions on keypad

| Symbol | Name | Function |
|---|------------------|--|
|  | Escape | Enter or exit Level I menu |
|  | Enter | Enter the menu interfaces level by level, and confirm the parameter setting |
|  | Increment | Increase data or function code |
|  | Decrement | Decrease data or function code |
|  | Shift | Select the displayed parameters in turn in the stop or running state, and select the digit to be modified when modifying parameters |
|  | Multifunction | Perform function switchover (such as jog run and quick switchover of command source or direction) according to the setting of F16.00 |
|  | potentiometer | With the same function as AI1/AI2 |
|  | Run | Start the inverter in the keypad control mode |
|  | Stop/Reset | Stop the inverter when it is in the running state and perform the reset operation when it is in the fault state. The functions of this key are restricted in F16.01. |
|  | Key combinations | The inverter will free stop when the run and stop key are pressed simultaneously |

4.1.2 Keypad Indicators

There are 8 Indicators on the keypad, whose descriptions are as shown in Table 4-2.

Table 4-2 Description of indicators

| Indicator | Name | Meaning |
|-----------|---|---|
| Unit | Hz | Frequency ON: currently displayed parameter is frequency |
| | V | Voltage ON: currently displayed parameter is voltage |
| | A | Current ON: currently displayed parameter is current |
| | % | Percentage ON: currently displayed parameter is percentage |
| | All off | Other unit Other unit or no unit |
| State | FWD/REV | Forward or reverse ON: the drive is running reverse OFF: the drive is running forward Flash: dormant state |
| | LOC/REM | Keypad, terminals or communication ON: Terminal control OFF: Keypad control Flash: Communication control |
| |  (Green border) | Running state ON: Running state OFF: Stopped state Flash: In process of stop |
| |  (Red border) | Fault state ON: Fault state OFF: Normal state Flash: Warning state |

4.1.3 Keypad digital display

The keypad has five LED (digital) display, it can display a given frequency, output frequency and other parameters, monitoring data and alarm code. Table 4-3 shows meanings of the characters displayed on Keypad.

Table 4-3 Meanings of displayed characters

| Displayed character | Character Meaning | Displayed character | Character Meaning | Displayed character | Character Meaning | Displayed character | Character Meaning |
|---------------------|-------------------|---------------------|-------------------|---------------------|-------------------|---------------------|-------------------|
| 0 | 0 | R | A | l | l | S | S |
| 1 | 1 | b | b | J | J | f | T |
| 2 | 2 | C | C | Ʒ | K | t | t |
| 3 | 3 | c | c | L | L | U | U |
| 4 | 4 | d | d | n | N | u | u |
| 5 | 5 | E | E | n | n | y | y |
| 6 | 6 | F | F | o | o | - | - |
| 7 | 7 | G | G | P | p | 8. | 8. |
| 8 | 8 | H | H | q | q | . | . |
| 9 | 9 | h | h | r | r | | |

4.1.4 Message status

A message appears when the state of completion of certain operations. Prompt message characters and their meanings are specified in Table 4-4.

Table 4-4 Prompt characters

| Prompt symbol | Meaning | Prompt symbol | Meaning |
|---------------|------------|---------------|---|
| Err00~Err99 | Fault type | TUNE | Motor parameter identification in process |
| A00~A99 | Alarm type | -END- | Write parameter |

4.2 Viewing and Modifying Function Codes

The keypad of the FR600 adopts three-level menu. The three-level menu consists of function code group (Level I), function code (Level II), and function code setting value (level III), as shown in the figure 4-2.

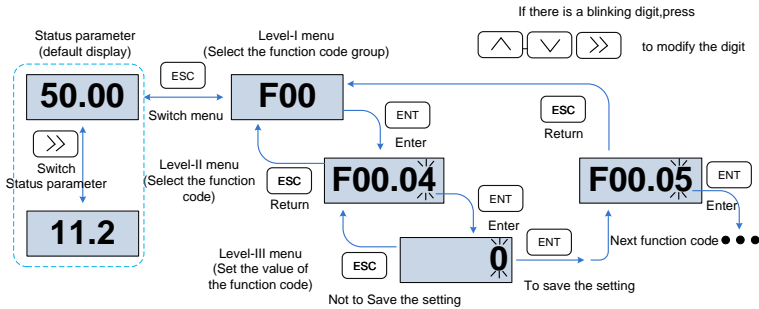

Fig.4-2 Operation procedure on the keypad

Explanation: In the level III menu, you can press the ESC key or ENT key to return to the level II menu. The difference is: If you do not have to modify the function code setting, press ENT will be automatically transferred to the next function code; If the function code settings are modified, it will display munu "-END-" 1 second when press ENT key, and redisplay the current function code settings, and it will be automatically transferred to the next function code when press the ENT key again. Press the ESC key to abandon the current parameter changes directly returns the current function code in level II.

Here is an example of changing the value of F1-02 to 15.00 Hz.

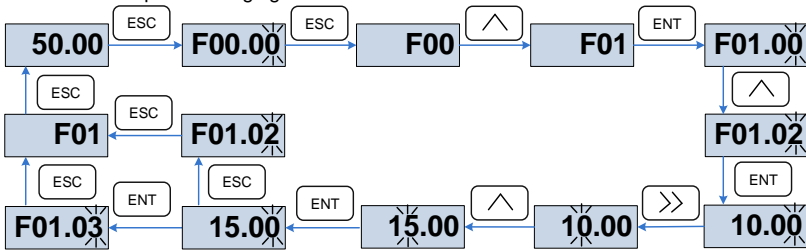

Fig.4-3 Example of changing the parameter value

In Level III menu, if the parameter has no blinking digit, it means that the parameter cannot be modified. This may be because:

- (1) Such a function code is only readable, such as, AC drive model, actually detected parameter and running record parameter.
- (2) Such a function code cannot be modified in the running state and can only be changed at stop.

4.3 Viewing Status Parameters

There are stop state parameters and running state parameters. It has 4 status parameters in the stop or running state. You can press ">>" on the keypad to display

status parameters. Which parameters are displayed is determined by the values of F16.03~F16.06 (Running state parameters 1~4)、F16.07~F16.10 (stop state parameters1~4), it can select the U00 group.

4.4 Motor Auto-tuning

Tuning is valid only when the keyboard command mode. Set tuning mode (stationary or rotating), press the ENT key to confirm, the keyboard will display TUNE, then press the RUN key, the inverter will drive motor acceleration and deceleration, positive inversion operation, and the run indicator lights. Tuning duration of about two minutes, when the display TUNE message disappears, returning to normal parameter display status, which means that the tuning is completed.

4.5 Password Setting

The inverter provides password protection function, it is set a user's password when F00.00 set to nonzero. If five minutes without operating the keypad, the password protection is effective, and the keypad will show "-----", then the user must enter the correct password to enter the regular menu, otherwise inaccessible.

There are three ways a user password into force:

Method 1: Set F00.00 parameter to nonzero, then press the ESC + ENT key.

Method 2: Set F00.00 parameter to nonzero, then do not use the keypad within five minutes.

Method 3: Set F00.00 parameter to nonzero, then completely power down and then power.

If you want to cancel the password protection functions, only through a password to enter, and set F00.00 to 0.

4.6 Keypad lock

4.6.1 Keypad lock

The following three methods to any one immediately lock all or part of the keypad buttons; see the definition of the function code F16.02.

Method 1: Set F16.02 parameter to nonzero, then press the ESC + ENT key.

Method 2: Set F16.02 parameter to nonzero, and then do not use the keypad within five minutes.

Method 3: Set F16.02 parameter to nonzero, then completely power down and then power.









4.6.2 Keypad unlock

Press the ESC + >> keys to unlock. Unlocking operation does not change the value of F16.02. That means when Meet the keypad locking conditions, the keypad will be locked again. If you want the control panel no longer be locked, after unlocking the F16.02 must change the value to 0.

4.7 Shortcut menu function code description

Factory setting mode is changed to be shortcut menu mode (F00.01=1) in the software version above V1.07, group 17 is for the parameters of shortcut menu.

The difference of display between shortcut manual and basic menu is in the second level menu, please refer to below the details of difference and the switching method.

| Menu mode | Shortcut menu | Basic menu |
|---------------------|---|--|
| Display difference | F01.01. The last digit of F01.01. function code is with radix point, no flashing | F01.01  F01.01 function code is without radix point, and flashing |
| Function difference | 1. Press  or  for up-down switch in F17 function code 2.  can't return back to first level menu | 1. Press  or  up-down switch in sequence 2. Press  return back to first level menu |
| Switch | Method 1. Setting F00.01=0 to basic menu | Method 1. Setting F00.01 to shortcut menu Method 2. Long press  when |

| | | |
|--|--|---|
| | Method 2. Long Press  when display second level menu, switch to basic menu automatically | display second level menu, switch to shortcut menu automatically |
|--|--|---|

If the shortcut menu is not enough, user can reset the shortcut menu, refer to group F17 for details.

Chapter 5 List of Parameter

Group F00~F17 are standard function parameters. Group U00 is status monitoring parameters. Group U01 is fault record parameters.

The symbols in the function code table are described as follows:

"△" means the value of this parameter can be modified in stop and running status of drive;

"×" means the value of this parameter cannot be modified when drive is running;

"

⊙" means this parameter is a m

Default: The value when restored to factory default. Neither measured parameter value nor recorded value will be restored.

Setting Range: the scope of setting and display of parameters

FR600 parameter groups are listed below:

| Category | Parameter Group |
|---------------------------------------|---|
| System Parameters | F00: System Parameters |
| Basic Parameters | F01: Frequency Command |
| | F02: Start/Stop Control Start/Stop Control |
| | F03: Accelerate/Decelerate Parameters |
| Input & Output Terminals | F04: Digital Input |
| | F05: Digital Output |
| | F06: Analog and Pulse Input |
| | F07: Analog and Pulse Output |
| | F22: Virtual IO |
| Motor and Control Parameters | F08: Parameters of Motor 1 |
| | F09: V/f Control Parameters of Motor 1 |
| | F10: Vector Control Parameters of Motor 1 |
| Protection Parameters | F11: Protection Parameters |
| Application Parameters | F12: Multi-Reference and Simple PLC Function |
| | F13: Process PID |
| | F14: Swing Frequency, Fixed Length , Count and Wakeup |
| Communication Parameters | F15: Communication Parameters |
| Keys and Display of Keypad Parameters | F16: Keys and Display of Keypad Parameters |
| User-defined Display Parameters | F17: User-defined Display Parameters |
| Monitoring Parameters | U00: Status monitoring |
| | U01: Fault record |

5.1 Five LED (digital) display indicators

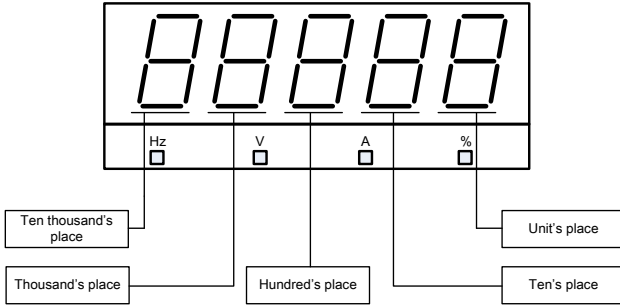

Fig.5-1 LED indicators

5.1 Standard Function Parameters

Table 5-1 Standard Function Parameters

| Param. | Parameter Name | Setting Range | Default | Attr |
|-------------------------------------|--|---|---------|------|
| Group F00: System Parameters | | | | |
| F00.00 | Setting of User Password | 0~65535 | 0 | × |
| F00.01 | Display of Parameters | 0: Display all parameters | 0 | × |
| | | 1: Only display F00.00, F00.01 and user-defined parameters F17.00~F17.29 | | |
| | | 2: Only display A0-00, A0-01, and the parameters different with factory default | | |
| F00.02 | Parameter Protection | 0: All parameter programmable 1: Only F00.02 and this parameter programmable | 0 | × |
| F00.04 | Parameter Initialization | 0: No operation | 0 | × |
| | | 1: Restore all parameters to factory default (excluding motor parameters) | | |
| | | 2: Clear fault record | | |
| | | 3: Back up current user parameters | | |
| | | 4: Restore user backup parameters | | |
| | | 5: Restore factory default(include motor parameter) | | |
| F00.05 | Copy of Parameters(Need an uploading and downloading module) | 0: No operation | 0 | × |
| | | 1: Upload parameter | | |
| | | 2: Download parameter (excluding motor parameters) | | |
| F00.06 | Parameter editing mode | 0:Editable via keypad and RS485 | 0 | × |
| | | 1:Editable via keypad | | |
| | | 2:Editable via RS485 | | |
| F00.08 | Motor 1 control mode | 0: Voltage/Frequency (V/F) control | 1 | × |
| | | 1:Sensor-less vector control 1 | | |

| | | | | |
|-------------------------------------|----------------------------|--|---------------|---|
| | | 2: Sensor-less vector control 2 | | |
| F00.09 | DI7/HI input mode | 0: Digital input terminal 7 1: Pulse input | 0 | × |
| F00.10 | AI1\AI2\AI3 input mode | Unit's place: AI1 0: Analog input 1: Digital input Decade: AI2 (same as AI1) Hundreds place: AI3 (same as AI1) | 000 | × |
| F00.11 | Y2/HO input mode | 0: Digital Output terminal 2 1: Pulse output | 0 | × |
| F00.12 | PWM optimization | Unit's place: PWM modulation mode 0: Fixed carrier 1: Random carrier 2: Derating of fixed carrier 3: Derating of random carrier Decade: PWM modulation mode 0: Seven-segment mode 1: Five-segment mode 2: Five-segment and seven-segment automatic switchover Hundreds place: over-modulation adjustment 0: Disabled 1: Enabled | 000 | × |
| F00.13 | Carrier frequency | 0.700~16.000kHz | Model defined | △ |
| F00.14 | Upper carrier frequency | 0.700~16.000kHz | 8.000kHz | × |
| F00.15 | Lower carrier frequency | 0.700~16.000kHz | 2.000kHz | × |
| F00.16 | Output voltage | 5.0~150.0% | 100.0% | × |
| F00.17 | AVR | 0: Disabled 1: Enabled 2: AVR is disabled if the DC bus voltage > the rated voltage of DC bus, and it will be enabled if the DC bus voltage ≤ the rated voltage of DC bus. | 1 | × |
| F00.18 | Fan control | 0: Run at power-on 1: Fan working during running | 1 | × |
| F00.19 | Factory password | 0~65535 | 0 | × |
| F00.20 | Inverter rated power | 0.2~710.0kW | Model defined | ⊙ |
| F00.21 | Inverter rated voltage | 60~660V | Model defined | ⊙ |
| F00.22 | Inverter rated current | 0.1~1500.0A | Model defined | ⊙ |
| F00.23 | Software version | 0.00~655.35 | Model defined | ⊙ |
| F00.24 | Dealer password | 0~65535 | 0 | × |
| F00.25 | Setting operation time | 0~65535h(0: Invaild) | 0h | × |
| Group F01: Frequency Command | | | | |
| F01.00 | Frequency source selection | 0: Master frequency source 1: Auxiliary frequency source | 0 | × |

| | | | | |
|--------------------------------------|---|--|---------|---|
| | | 2: Master +Auxiliary | | |
| | | 3: Master - Auxiliary | | |
| | | 4: MAX{Master, Auxiliary } | | |
| | | 5: MIN {Master, Auxiliary } | | |
| | | 6: AI1 (Master + Auxiliary) | | |
| | | 7: AI2 (Master +Auxiliary) | | |
| F01.01 | Master Frequency Command Source | 0:Master digital setting (F01.02) | 1 | x |
| | | 1: keypad potentiometer | | |
| | | 2: Analog input AI1 | | |
| | | 3: Communication | | |
| | | 4: Multi-reference | | |
| | | 5: PLC | | |
| | | 6: Process PID output | | |
| | | 7: X7/HI pulse input | | |
| | | 8: AI2 | | |
| | | 9: AI3 | | |
| F01.02 | Digital Setting of Master Frequency | 0.00~Fmax | 50.00Hz | △ |
| F01.03 | Auxiliary Frequency Command Source | 0: Auxiliary digital setting (F01.04) | 0 | x |
| | | 1: keypad potentiometer | | |
| | | 2: Analog input AI1 | | |
| | | 3: Communication | | |
| | | 4: Multi-reference | | |
| | | 5: PLC | | |
| | | 6: Process PID output | | |
| | | 7: X7/HI pulse input | | |
| | | 8: Analog input AI2 | | |
| | | 9: Analog input AI3 | | |
| F01.04 | Digital setting of auxiliary frequency | 0.00~Fmax | 50.00Hz | △ |
| F01.05 | Range of auxiliary frequency | 0: Relative to maximum frequency | 0 | x |
| | | 1: Relative to master frequency | | |
| F01.06 | Coeff of auxiliary frequency | 0.0~150.0% | 100.0% | △ |
| F01.07 | Jog frequency | 0.00~Fmax | 5.00Hz | △ |
| F01.08 | Maximum frequency | 20.00~600.00Hz | 50.00Hz | x |
| F01.09 | Upper limit frequency | Fdown~Fmax Lower limit frequency~maximum frequency | 50.00Hz | x |
| F01.10 | Lower limit frequency | 0.00~Fup | 0.00Hz | x |
| F01.11 | Operation when command frequency lower than lower limit frequency | 0: Run at lower limit frequency | 0 | x |
| | | 1: Run at 0 Hz would be activated after the time delay set by F01.12 | | |
| F01.12 | Lower limit frequency running time | 0.0~6000.0s | 60.0s | x |
| F01.13 | Up to this frequency, start frequency compensation | 0.00~600.00Hz | 50.00Hz | △ |
| F01.14 | Frequency compensation per 50Hz | 0.00~50.00Hz | 0.00Hz | △ |
| Group F02: Start/Stop Control | | | | |
| F02.00 | Run command | 0: Keypad control (LED off) | 0 | x |
| | | 1: Terminal control (LED on) | | |
| | | 2: Communication control (LED blinking) | | |

| | | | | |
|--|--|---|--------|---|
| F02.01 | Running direction | 0: Forward | 0 | △ |
| | | 1: Reverse | | |
| F02.02 | Reverse-proof action | 0: Reverse enabled | 0 | × |
| | | 1: Reverse disabled | | |
| F02.03 | Dead time between forward and reverse | 0.0~6000.0s | 0.0s | × |
| F02.04 | Start mode | Unit's place: 0:Start directly 1:Rotational speed track and restart | 0000 | × |
| | | Ten's place: 0:Ungrounded short-circuit detection 1:Grounding short-circuit detection before the first starts 2:Grounding short-circuit detection before each starts | | |
| | | Hundred's place: Speed tracking 0:Track from zero speed 1:Track from max frequency | | |
| | | Thousand's place: Select if Jog function takes the priority 0:Disable 1:Enable | | |
| F02.05 | Start frequency | 0.00~10.00Hz | 0.00Hz | × |
| F02.06 | Startup frequency holding time | 0.0~100.0s | 0.0s | × |
| F02.07 | Startup DC braking current | 0.0~150.0% | 0.0% | × |
| F02.08 | DC braking time at start | 0.0~100.0s | 0.0s | × |
| F02.09 | Speed search current | 0.0~180.0% | 130.0% | △ |
| F02.10 | Speed search decel time | 0.0~10.0s | 1.0s | × |
| F02.11 | Speed search coefficient | 0.01~5.00 | 0.30 | △ |
| F02.12 | Stop mode | 0: Ramp to stop | 0 | × |
| | | 1: Coast to stop | | |
| F02.13 | Initial frequency of stop DC braking | 0.01~50.00Hz | 2.00Hz | × |
| F02.14 | Stop DC braking current | 0.0~150.0% | 0.0% | × |
| F02.15 | Waiting time of stop DC braking | 0.0~30.0s | 0.0s | × |
| F02.16 | Stop DC braking time | 0.0~30.0s | 0.0s | × |
| F02.17 | Dynamic brake | 0: Disabled | 0 | × |
| | | 1: Enabled | | |
| | | 2: Enabled at running | | |
| | | 3: Enabled at deceleration | | |
| F02.18 | Voltage of dynamic braking | 800~1200V | 1050V | × |
| F02.19 | Brake use ratio | 5.0~100.0% | 100.0% | × |
| F02.20 | 0Hz output selection | 0: No voltage output | 0 | × |
| | | 1: Voltage output | | |
| F02.21 | Auto-start of power-on again | 0: Invalid | 0 | △ |
| | | 1: Valid | | |
| F02.22 | Waiting time between auto-start and power-on again | 0.0~10.0s | 0.5s | △ |
| Group F03: Accel/Decel Parameters | | | | |

| | | | | |
|---------------------------------------|--|---|--------|---|
| F03.00 | Accel time 1 | 0.0~6000.0s | 15.0s | △ |
| F03.01 | Decel time 1 | 0.0~6000.0s | 15.0s | △ |
| F03.02 | Accel time 2 | 0.0~6000.0s | 15.0s | △ |
| F03.03 | Decel time 2 | 0.0~6000.0s | 15.0s | △ |
| F03.04 | Accel time 3 | 0.0~6000.0s | 15.0s | △ |
| F03.05 | Decel time 3 | 0.0~6000.0s | 15.0s | △ |
| F03.06 | Accel time 4 | 0.0~6000.0s | 15.0s | △ |
| F03.07 | Decel time 4 | 0.0~6000.0s | 15.0s | △ |
| F03.08 | Jog accel time | 0.0~6000.0s | 15.0s | △ |
| F03.09 | Jog decel time | 0.0~6000.0s | 15.0s | △ |
| F03.10 | Accel/Decel curve | 0: Linear Accel/Decel | 0 | × |
| | | 1: S-curve Accel/Decel | | |
| F03.11 | Initial segment time of acceleration of S curve | 0.0~6000.0s | 0.0s | × |
| F03.12 | Time unit of acceleration and deceleration | 0: 0.1s | 0 | × |
| | | 1: 0.01s | | |
| F03.13 | Frequency switchover point between acceleration time 1 and acceleration time 2 | 0.00~Fmax | 0.00Hz | × |
| F03.14 | Frequency switchover point between deceleration time 1 and deceleration time 2 | 0.00~Fmax | 0.00Hz | × |
| F03.15 | End segment time of acceleration of S curve | 0.0~6000.0s | 0.0s | × |
| F03.16 | Initial segment time of deceleration of S curve | 0.0~6000.0s | 0.0s | × |
| F03.17 | End segment time of deceleration of S curve | 0.0~6000.0s | 0.0s | × |
| Group F04 Digital Input | | | | |
| F04.00 | Function of terminal DI1 | 00: No function | 1 | × |
| F04.01 | Function of terminal DI2 | 01: Running forward (FWD) | 2 | × |
| F04.02 | Function of terminal DI3 | 02: Running reverse (REV) | 7 | × |
| F04.03 | Function of terminal DI4 | 03: Three-wire control | 13 | × |
| F04.04 | Function of terminal DI5 | 04: JOG forward | 0 | × |
| F04.05 | Function of terminal DI6 | 05: JOG reverse | 0 | × |
| F04.06 | Function of terminal DI7 | 06: Coast to stop | 0 | × |
| F04.07 | Function of terminal AI1 | 07: Fault reset (RESET) | 0 | × |
| F04.08 | Function of terminal AI2 | 08: Running suspended | 0 | × |
| F04.09 | Function of terminal AI3 | 09: External fault input | 0 | × |
| | | 10: Terminal UP | | |
| | | 11: Terminal DOWN | | |
| | | 12: UP/DOWN (including key) adjustment clear | | |
| | | 13: Multi-step frequency terminal 1 | | |
| | | 14: Multi-step frequency terminal 2 | | |
| | | 15: Multi-step frequency terminal 3 | | |
| | | 16: Multi-step frequency terminal 4 | | |
| | | 17: Accel/Decel time determinant 1 | | |
| | | 18: Accel/Decel time determinant 2 | | |
| | | 19: Accel/Decel disabled(ramp stop not inclusive) | | |
| 20: Switch to auxiliary speed setting | | | | |
| 21: PLC status reset | | | | |

| | | | | |
|--------|---|--|--------|---|
| | | 22: Simple PLC paused 23: Simple PLC paused 24: PID adjustment direction 25: PID integration paused 26: PID parameter switch 27: Swing frequency pause(output the current frequency) 28: Swing frequency reset(output the central frequency) 29: Run command switched to keypad control 30: Run command switched to terminal control 31: Run command switched to communication control 32: Count input 33: Count clear 34: Length count 35: Length clear 36: DC brake input command at Stop 37: Speed/torque control switch 38: No reverse 39: No forward | | |
| F04.10 | Filtering time of digital input terminal | 0.000~1.000s | 0.010s | △ |
| F04.11 | Delay time before terminal DI1 is valid | 0.0~300.0s | 0.0s | △ |
| F04.12 | Delay time before terminal DI2 is valid | 0.0~300.0s | 0.0s | △ |
| F04.13 | Terminal DI1~DI5 positive/negative logic | DI5、DI4、DI3、DI2、DI1 0: Positive logic(Terminals are on at 0V/off at 24V) 1: Negative Logic (Terminals are off at 0V/on at 24V) | 00000 | × |
| F04.14 | Terminal DI6~AI3 positive/negative logic | AI3、AI2、AI1、DI7、DI6 0: Positive logic 1: Negative Logic | 00000 | × |
| F04.15 | FWD/REV terminal control mode | 0: Two-wire mode 1 1: Two-wire mode 2 2: Three-wire mode 1 3: Three-wire mode 2 | 0 | × |
| F04.16 | Terminal UP/DOWN frequency adjustment control | Unit's place: action when stop 0: Clear 1: Holding Ten's place: action on power loss 0: Clear 1: Holding Hundreds place: integral function 0: No integral function 1: Integral function enabled Thousand's place: Select if it can be reduced to negative frequency 0: Disable 1: Enable Ten thousand's place: Jog action to clear UP/DOWN | 00001 | × |

| | | | | |
|---|---|---|------------------|---|
| | | 0: Not Clear 1: Clear | | |
| F04.17 | Terminal UP/DOWN frequency change step size | 0.00~50.00Hz 0.00:Disabled | 1.00Hz/ 200ms | △ |
| F04.18 | Terminal action selection when power on | 0: Level effective | 0 | × |
| | | 1: Edge trigger +Level effective(When power on) | | |
| | | 2: Edge trigger +Level effective(Every start) | | |
| F04.19 | Delay time before terminal DI1 is invalid | 0.0~300.0s | 0.0s | △ |
| F04.20 | Delay time before terminal DI2 is invalid | 0.0~300.0s | 0.0s | △ |
| Group F05 Digital Output | | | | |
| F05.00 | Y1 output function | 00: No output | 1 | × |
| F05.01 | Y2 output function | 01: Drive is running | 3 | |
| F05.02 | Relay 1 output function | 02: Fault output | 2 | × |
| F05.03 | Relay 2 output function | 03: Frequency-level detection FDT1 output | 11 | × |
| | | 04: Frequency-level detection FDT2 output | | |
| | | 05: Drive in 0Hz running 1(no output at stop) | | |
| | | 06: Drive in 0Hz running 2(output at stop) | | |
| | | 07: Upper limit frequency attained | | |
| | | 08: Lower limit frequency attained | | |
| | | 09: Frequency attained | | |
| | | 10: Inverter is ready to work | | |
| | | 11: Drive (motor) overloaded alarm | | |
| | | 12: Inverter overheat warning | | |
| | | 13: Current running time attained | | |
| | | 14: Accumulative power-on time attained | | |
| | | 15: Consecutive running time attained | | |
| | | 16: PLC cycle completed | | |
| | | 17: Set count value attained | | |
| 18: Designated count value attained | | | | |
| 19: Length attained | | | | |
| 20: Under load alarm | | | | |
| 21: Brake output | | | | |
| 22: DI1 | | | | |
| 23: DI2 | | | | |
| 24: When reach the range of set frequency(FDT1) | | | | |
| F05.04 | Y1 output delay time | 0.0~6000.0s | 0.0s | △ |
| F05.05 | Y2 output delay time | 0.0~6000.0s | 0.0s | △ |
| F05.06 | R1 output delay time | 0.0~6000.0s | 0.0s | △ |
| F05.07 | R2 output delay time | 0.0~6000.0s | 0.0s | △ |
| F05.08 | Enabled state of digital output | Unit's place: Y1 | 0000 | × |
| | | 0: Positive logic | | |
| | | 1: Negative logic | | |
| | | Ten's place: Y2 (same as unit's place) | | |

| | | | | |
|---|---|---|---------|---|
| | | Hundreds place: Relay 1 output (same as unit's place) | | |
| | | Thousands place: Relay 2 output (same as unit's place) | | |
| F05.09 | Detection width of frequency attained | 0.00~20.00Hz | 5.00Hz | × |
| F05.10 | FDT1 upper bound | 0.00~Fmax | 30.00Hz | × |
| F05.11 | FDT1 lower bound | 0.00~Fmax | 30.00Hz | × |
| F05.12 | FDT2 upper bound | 0.00~Fmax | 30.00Hz | × |
| F05.13 | FDT2 lower bound | 0.00~Fmax | 30.00Hz | × |
| F05.14 | Consecutive running time | 0.0~6000.0Min 0.0:Disabled | 0.0Min | × |
| F05.15 | Accumulative power-on time setting | 0~65535h 0:Disabled | 0h | × |
| F05.16 | Accumulative running time setting | 0~65535h 0:Disabled | 0h | × |
| F05.17 | Brake control selection | 0: Disabled 1: Enabled | 0 | × |
| F05.18 | Brake opened frequency | Closed frequency ~30.00Hz | 2.50Hz | × |
| F05.19 | Brake opened current | 0.0~200.0% | 0.0% | △ |
| F05.20 | Brake open waiting time | 0.00~10.00s | 0.00s | × |
| F05.21 | Brake open operating time | 0.00~10.00s | 0.50s | × |
| F05.22 | Brake closed frequency | 0.00Hz~opened frequency | 2.00Hz | × |
| F05.23 | Brake close waiting time | 0.00~10.00s | 0.00s | × |
| F05.24 | Brake close operating time | 0.00~10.00s | 0.50s | × |
| Group F06 Analog and Pulse Input | | | | |
| F06.00 | Minimum input of curve AI1 | 0.0%~input of inflection point1 of curve AI1 | 1.0% | △ |
| F06.01 | Set value corresponding to minimum input of curve AI1 | -100.0~100.0% | 0.0% | △ |
| F06.02 | Input of inflection point 1 of curve AI1 | Minimum input of curve AI1~Input of inflection point 2 of curve AI1 | 100.0% | △ |
| F06.03 | Set value corresponding to input of inflection point 1 of curve AI1 | -100.0~100.0% | 100.0% | △ |
| F06.04 | Input of inflection point 2 of curve AI1 | Input of inflection point 1 of curve AI1~Maximum input of curve AI1 | 100.0% | △ |
| F06.05 | Set value corresponding to input of inflection point 2 of curve AI1 | -100.0~100.0% | 100.0% | △ |
| F06.06 | Maximum input of curve AI1 | Input of inflection point 2 of curve AI1~100.0% | 100.0% | △ |
| F06.07 | Set value corresponding to maximum input of curve AI1 | -100.0~100.0% | 100.0% | △ |
| F06.08 | Minimum input of curve AI2 | 0.0%~input of inflection point1 of curve AI2 | 1.0% | △ |
| F06.09 | Set value corresponding to minimum input of curve AI2 | -100.0~100.0% | 0.0% | △ |
| F06.10 | Input of inflection point 1 of curve AI2 | Minimum input of curve AI1~Input of inflection point 2 of curve AI2 | 100.0% | △ |
| F06.11 | Set value corresponding to input of inflection | -100.0~100.0% | 100.0% | △ |

| | | | | |
|--------|--|---|----------|---|
| | point 1 of curve AI2 | | | |
| F06.12 | Input of inflection point 2 of curve AI2 | Input of inflection point 1 of curve AI2~Maximum input of curve AI2 | 100.0% | △ |
| F06.13 | Set value corresponding to input of inflection point 2 of curve AI2 | -100.0~100.0% | 100.0% | △ |
| F06.14 | Maximum input of curve AI2 | Input of inflection point A of curve AI2~100.0% | 100.0% | △ |
| F06.15 | Set value corresponding to maximum input of curve AI2 | -100.0~100.0% | 100.0% | △ |
| F06.16 | Minimum input of curve AI3 | 0.0%~input of inflection point1 of curve AI3 | 0.0% | △ |
| F06.17 | Set value corresponding to minimum input of curve AI3 | -100.0~100.0% | -100.0% | △ |
| F06.18 | Input of inflection point 1 of curve AI3 | Minimum input of curve AI1~Input of inflection point 2 of curve AI3 | 25.0% | △ |
| F06.19 | Set value corresponding to input of inflection point 1 of curve AI3 | -100.0~100.0% | -50.0% | △ |
| F06.20 | Input of inflection point 2 of curve AI3 | Input of inflection point 1 of curve AI3~Maximum input of curve AI3 | 75.0% | △ |
| F06.21 | Set value corresponding to input of inflection point 2 of curve AI3 | -100.0~100.0% | 25.0% | △ |
| F06.22 | Maximum input of curve AI3 | Input of inflection point A of curve AI3~100.0% | 100.0% | △ |
| F06.23 | Set value corresponding to maximum input of curve AI3 | -100.0~100.0% | 100.0% | △ |
| F06.24 | Minimum input of curve keypad potentiometer | 0.0~Maximum input of curve keypad potentiometer | 0.5% | △ |
| F06.25 | Set value corresponding to minimum input of curve keypad potentiometer | -100.0~100.0% | 0.0% | △ |
| F06.26 | Maximum input of curve keypad potentiometer | Minimum input of curve keypad potentiometer~100.0 | 99.9% | △ |
| F06.27 | Set value corresponding to maximum input of curve keypad potentiometer | -100.0~100.0% | 100.0% | △ |
| F06.28 | AI1 terminal filtering time | 0.000~10.000s | 0.100s | △ |
| F06.29 | AI2 terminal filtering time | 0.000~10.000s | 0.100s | △ |
| F06.30 | AI3 terminal filtering time | 0.000~10.000s | 0.100s | △ |
| F06.31 | Keypad potentiometer filtering time | 0.000~10.000s | 0.100s | △ |
| F06.32 | Minimum input of curve HI | 0.00 kHz~Maximum input of curve HI | 0.00kHz | △ |
| F06.33 | Set value corresponding to minimum input of curve HI | -100.0~100.0% | 0.0% | △ |
| F06.34 | Maximum input of curve HI | Minimum input of curve HI~100.00kHz | 50.00kHz | △ |
| F06.35 | Set value corresponding to maximum input of curve HI | -100.0~100.0% | 100.0% | △ |

| | | | | |
|--|--|---|---------------|------|
| F06.36 | HI terminal filtering time | 0.000~10.000s | 0.100s | △ |
| Group F07 Analog and Pulse Output | | | | |
| F07.00 | AO1 output function | 00: No output 01: Output frequency 02: Command frequency 03: Output current 04: Output voltage 05: Output power 06: Bus voltage 07: +10V 08: keypad potentiometer 09: AI1 10: AI2 11: AI3 12: HI 13: Output torque 14: Ao communication given 1 15: Ao communication given 2 | 1 | × |
| F07.01 | AO2 output function | | 2 | × |
| F07.02 | Y2/HO output function (when used as HO) | | 3 | × |
| F07.03 | AO1 offset | | -100.0~100.0% | 0.0% |
| F07.04 | AO1 gain | -2.000~2.000 | 1.000 | △ |
| F07.05 | AO1 filtering time | 0.000~10.000s | 0.000s | △ |
| F07.06 | AO2 offset | -100.0~100.0% | 0.00% | △ |
| F07.07 | AO2 gain | -2.000~2.000 | 1.000 | △ |
| F07.08 | AO2 filtering time | 0.000~10.000s | 0.000s | △ |
| F07.09 | HO maximum output pulse frequency | 0.01~100.00kHz | 50.00kHz | △ |
| F07.10 | HO output filtering time | 0.000~10.000s | 0.010s | △ |
| Group F08 Parameters of Motor 1 | | | | |
| F08.00 | Motor 1 type selection | 0: Three phase asynchronous motors | 0 | × |
| | | 1: Reserved | | |
| | | 2: Single phase asynchronous motors (Remove capacity) | | |
| | | 3: Single phase asynchronous motors (No need to remove capacity) | | |
| F08.01 | Power rating of motor 1 | 0.1~1000.0kW | Model defined | × |
| F08.02 | Rated voltage of motor 1 | 60~660V | Model defined | × |
| F08.03 | Rated current of motor 1 | 0.1~1500.0A | Model defined | × |
| F08.04 | Rated frequency of motor 1 | 20.00~Fmax | Model defined | × |
| F08.05 | Rated speed of motor 1 | 1~30000 | Model defined | × |
| F08.08 | Stator resistance R1 of async motor 1 | 0.001~65.535Ω | Model defined | × |
| F08.09 | Rotor resistance R2 of async motor 1 | 0.001~65.535Ω | Model defined | × |
| F08.10 | Leakage inductance L1 of async motor 1 | 0.01~655.35mH | Model defined | × |
| F08.11 | Mutual inductance L2 of asynchronous motor 1 | 0.1~6553.5mH | Model defined | × |
| F08.12 | No-load current of async motor 1 | 0.1~1500.0A | Model defined | × |

| | | | | |
|--|--|--------------------------------------|---------|---|
| F08.13 | Field weakening coeff 1 of async motor 1 | 0.0~100.0 | 87% | × |
| F08.14 | Field weakening coeff 2 of async motor 1 | 0.0~100.0 | 75% | × |
| F08.15 | Field weakening coeff 3 of async motor 1 | 0.0~100.0 | 70% | × |
| F08.21 | Motor's pole number | 0~1000 | 4 | ⊙ |
| F08.30 | Autotuning of motor 1 | 0: No autotuning | 0 | × |
| | | 1: Static autotuning of async motor | | |
| | | 2: Rotary autotuning of async motor | | |
| Group F09 V/f Control Parameters of Motor 1 | | | | |
| F09.00 | V/f curve setting | 00: Linear V/F | 0 | × |
| | | 01: Multi-stage V/F | | |
| | | 02:1.2nd power V/F | | |
| | | 03:1.4th power V/F | | |
| | | 04:1.6th power V/F | | |
| | | 05:1.8th power V/F | | |
| | | 06: 2.0nd power V/F | | |
| | | 07: V/F complete separation | | |
| | | 08: V/F half separation | | |
| | | 09: 1.2 power inverse curve V/F | | |
| | | 10: 1.4 power inverse curve V/F | | |
| | | 11: 1.6 power inverse curve V/F | | |
| | | 12: 1.8 power inverse curve V/F | | |
| 13: 2.0 power inverse curve V/F | | | | |
| F09.01 | Torque boost | 0.1%~30.0% 0.0% (fixed torque boost) | 0.0% | △ |
| F09.02 | Cut-off frequency of torque boost | 0.00~Fmax | 50.00Hz | △ |
| F09.03 | Multi-point V/F frequency 1(F1) | 0.00~F09.05 | 0.00Hz | △ |
| F09.04 | Multi-point V/F voltage 1 (V1) | 0.0~100.0 | 5.0% | △ |
| F09.05 | Multi-point V/F frequency 2(F2) | F09.03~F09.05 | 5.00Hz | △ |
| F09.06 | Multi-point V/F voltage 2 (V2) | 0.0~100.0 | 14.0% | △ |
| F09.07 | Multi-point V/F frequency 3(F3) | F09.05~F09.09 | 25.00Hz | △ |
| F09.08 | Multi-point V/F voltage 3 (V3) | 0.0~100.0 | 50.0% | △ |
| F09.09 | Multi-point V/F frequency 4(F4) | F09.07~rated motor frequency | 50.00Hz | △ |
| F09.10 | Multi-point V/F voltage 4 (V4) | 0.0~100.0 Ue=100.0% | 100.0% | △ |
| F09.11 | V/F slip compensation gain | 0.0~300.0% | 80.0% | △ |
| F09.12 | Stator voltage drop compensation gain | 0.0~200.0% | 100.0% | △ |
| F09.13 | Excitation boost gain | 0.0~200.0% | 100.0% | △ |
| F09.14 | Oscillation Suppression | 0.0~300.0% | 100.0% | △ |
| F09.15 | Voltage source for V/F separation | 0: Digital setting (F09.16) | 0 | × |
| | | 1: keypad potentiometer | | |
| | | 2: AI1 | | |
| | | 3: Multi-reference | | |

| | | | | |
|---|---|--|---------|---|
| | | 4: Pulse setting (DI7/HI) | | |
| | | 5: PID | | |
| | | 6: AI2 | | |
| | | 7: AI3 | | |
| F09.16 | Voltage digital setting for V/F separation | 0 V to rated motor voltage | 0.0% | △ |
| F09.17 | Voltage rise time of V/F separation | 0.0~6000.0s It indicates the time for the voltage rising from 0 V to rated Motor voltage. | 0.1s | △ |
| Group F10 Vector Control Parameters of Motor 1 | | | | |
| F10.00 | Speed/torque control | 0: speed control 1: torque control | 0 | × |
| F10.01 | ASR low-speed proportional gain Kp1 | 0.0~100.0 | 15.0 | △ |
| F10.02 | ASR low-speed integration time Ti1 | 0.001~30.000s | 0.050s | △ |
| F10.03 | ASR switching frequency 1 | 0.00~F10.06 | 5.00Hz | △ |
| F10.04 | ASR high-speed proportional gain Kp2 | 1~100.0 | 10.0 | △ |
| F10.05 | ASR high-speed integration time Ti2 | 0.001~30.000s | 0.100s | △ |
| F10.06 | ASR switching frequency 2 | F10.03~Fmax | 10.00Hz | △ |
| F10.07 | ASR input filtering time | 0.0~500.0ms | 3.0ms | △ |
| F10.08 | ASR output filtering time | 0.0~500.0ms | 0.0ms | △ |
| F10.09 | Vector control slip gain | 50~200% | 100% | △ |
| F10.10 | Digital setting of torque upper limit in speed control mode | 80.0~200.0% | 165.0% | × |
| F10.11 | Excitation adjustment proportional gain Kp1 | 0.00~10.00 | 0.50 | △ |
| F10.12 | Excitation adjustment integral gain Ti1 | 0.0~3000.0ms | 10.0ms | △ |
| F10.13 | Torque adjustment proportional gain Kp2 | 0.00~10.00 | 0.50 | △ |
| F10.14 | Torque adjustment integral gain Ti2 | 0.0~3000.0ms | 10.0ms | △ |
| F10.15 | Excitation gain coefficient | 50.0~200% | 100% | △ |
| F10.16 | Torque setting source under torque control | 0: Set by F10.17 1: Keypad potentiometer 2: AI1 3: AI2 4: AI3 5: Pulse setting (DI7/HI) 6: Communication setting | 0 | × |
| F10.17 | Digital setting of torque | -200.0~200.0% | 50.0% | △ |
| F10.18 | Forward speed limited value under torque control | 0.00~Fmax | 50.00Hz | △ |
| F10.19 | Reverse speed limited value under torque control | 0.00~ Fmax | 50.00Hz | △ |
| F10.20 | Set torque accel time | 0.0~6000.0s | 0.0s | △ |
| F10.21 | Set torque decel time | 0.0~6000.0s | 0.0s | △ |
| F10.22 | Static friction torque compensation | 0.0~100.0% | 5.00% | △ |

| | | | | |
|--|--|---|--------|---|
| F10.23 | Static friction frequency range | 0.00~20.00Hz | 1.00Hz | △ |
| F10.24 | Sliding friction torque compensation | 0.0~100.0% | 1.0% | △ |
| F10.25 | Rotary inertia compensation coeff | 0.0~200.0% | 30.0% | △ |
| F10.26 | Max Frequency source under torque control | 0: Set by F10.18 & F10.19 | 0 | × |
| | | 1: Keypad potentiometer | | |
| | | 2: AI1 | | |
| | | 3: AI2 | | |
| | | 4: AI3 | | |
| Group F11 Protection Parameters | | | | |
| F11.00 | Current limit control | 0: Current limit disabled | 2 | × |
| | | 1: Current limit mode 1 | | |
| | | 2: Current limit mode 2 | | |
| F11.01 | Current limit | 100.0~200.0% | 150.0% | × |
| F11.02 | Frequency decreasing time(limit current in constant speed operation) | 0.0~6000.0s | 5.0s | △ |
| F11.03 | Current limit mode 2 proportion gain | 0.1~100.0% | 3.0% | △ |
| F11.04 | Current limit mode 2 integral time | 0.00~10.00s | 10.00s | △ |
| F11.05 | Overvoltage Stall Control | 0: Overvoltage stall disabled | 2 | × |
| | | 1: Overvoltage stall mode 1 | | |
| | | 2: Overvoltage stall mode 2 | | |
| F11.06 | Overvoltage stall voltage | 900~1200V | 1050V | × |
| F11.07 | Overvoltage Stall Mode 2 Proportion Gain | 0.0~100.0% | 50.0% | △ |
| F11.08 | Overvoltage stall mode 2 frequency limit | 0.00~50.00Hz | 5.00Hz | × |
| F11.10 | Protection action 1 | Unit's place: Bus undervoltage | 03330 | × |
| | | 0: Fault reported and coast to stop | | |
| | | 1: Stop according to the stop mode | | |
| | | 2: Fault reported but continue to run | | |
| | | 3: Fault protection disabled | | |
| | | Ten's place:Power input phase Loss (Err09)(Same as unit's place) | | |
| | | Hundred's place:Power output phase loss(Err10)(Same as unit's place) | | |
| | | Thousand's place:Motor overload (Err11)(Same as unit's place) | | |
| Ten thousand's place:Inverter overload(Err11)(Same as unit's place) | | | | |
| F11.11 | Protection action 2 | External equipment fault (Err13) | 00000 | × |
| | | 0: Fault reported and coast to stop | | |
| | | 1: Stop according to the stop mode | | |
| | | 2: Fault reported but continue to run | | |
| | | Ten's place: EEPROM read/write fault (Err15) (Same as unit's place) | | |

| | | | | |
|--------|--|--|---------------|---|
| | | Hundred's place: Communication overtime error (Err18) (Same as unit's place) | | |
| | | Thousand's place: PID feedback loss (Err19) (Same as unit's place) | | |
| | | Ten thousand's place: Continuous running time reached (Err20) (Same as unit's place) | | |
| F11.12 | Protection action 3 | Unit's place: Module temperature detection disconnection (Err24) 0: Fault reported and coast to stop 1: Stop according to the stop mode 2: Fault reported but continue to run Ten's place: Load becoming 0 (Err25) (Same as unit's place) | 00030 | × |
| F11.14 | Frequency selection for continuing to run upon fault | 0: Current running frequency 1: Set frequency 2: Frequency upper limit 3: Frequency lower limit 4: Backup frequency upon abnormality | 1 | × |
| F11.15 | Backup frequency upon abnormality | 0.00~Fmax | 0.00Hz | × |
| F11.17 | Motor overload protection time | 30.0~300.0s | 60.0s | × |
| F11.18 | Overload alarm | Unit's place: detection option: 0: Always detect 1: Detect at constant speed only Ten's place: compared object 0: Rated current of motor 1: Rated current of drive Hundred's place: Fault reported 0: No fault reported 1: Fault reported Thousand' place: whether to decelerate or not when overload alarm 0: No deceleration 1: Deceleration Ten thousand's place: given mode for overload threshold 0: F11.19 set 1: F11.19*VP 2: F11.19*AI1 3: F11.19*AI2 4: F11.19*AI3 | 00010 | × |
| F11.19 | Overload alarm threshold | 20.0~200.0% | 130.0% | × |
| F11.20 | Overload alarm activated time that exceeding threshold | 0.1~60.0s | 5.0s | × |
| F11.21 | Inverter overheat warning threshold | 50~overheat Temperature | Model defined | × |
| F11.22 | Detection level of load loss | 5.0~100.0% | 20.0% | × |
| F11.23 | Detection time of load loss | 0.1~60.0s | 5.0s | × |
| F11.24 | Action selection at | 0: Disabled | 0 | × |

| | | | | |
|---|--|--|--------|---|
| | instantaneous power failure | 1: Deceleration 2: Bus voltage constant control | | |
| F11.25 | Decel time at instantaneous power failure | 0.0~6000.0s | 5.0s | △ |
| F11.26 | Rapid current limit | 0: Disabled 1: Enabled | 0 | × |
| F11.27 | Times of automatic trip(fault) reset | 0~20 | 0 | × |
| F11.28 | Interval of automatic trip(fault) reset | 0.1~100.0s | 1.0s | × |
| F11.29 | DO action during fault auto reset | 0: Not act 1: Act | 0 | × |
| F11.30 | Instantaneous power off bus voltage | 60.0%~Recovery voltage | 80.0% | △ |
| F11.31 | Instantaneous power off recovery voltage | Power off voltage~100.0% | 85.0% | △ |
| F11.32 | Instantaneous power off voltage detection time | 0.01~10.00s | 0.10s | △ |
| F11.33 | Instantaneous power off Kp | 0.1~100.0% | 40.0% | △ |
| F11.34 | Instantaneous power off integration time Ti | 0.00~10.00s (0.00: Integration invalid) | 0.10s | △ |
| F11.35 | Motor temperature sensor type | 0: Disabled 1: PT100 2: PT1000 | 0 | × |
| F11.36 | Motor temperature sensor current source port | 0: Disabled 1: AO1 2: AO2 | 0 | × |
| F11.37 | Motor temperature sensor input channels | 0: Disabled 1: AI1 2: AI2 3: AI3 | 0 | × |
| F11.38 | Motor temperature warning action threshold | 0~200 °C | 90 °C | △ |
| F11.39 | Motor temperature protection action threshold | 0~200 °C | 110 °C | △ |
| Group F12: Multi-Reference and Simple PLC Function | | | | |
| F12.00 | Reference 0 | -100.0~100.0% | 0.0% | △ |
| F12.01 | Reference 1 | -100.0~100.0% | 0.0% | △ |
| F12.02 | Reference 2 | -100.0~100.0% | 0.0% | △ |
| F12.03 | Reference 3 | -100.0~100.0% | 0.0% | △ |
| F12.04 | Reference 4 | -100.0~100.0% | 0.0% | △ |
| F12.05 | Reference 5 | -100.0~100.0% | 0.0% | △ |
| F12.06 | Reference 6 | -100.0~100.0% | 0.0% | △ |
| F12.07 | Reference 7 | -100.0~100.0% | 0.0% | △ |
| F12.08 | Reference 8 | -100.0~100.0% | 0.0% | △ |
| F12.09 | Reference 9 | -100.0~100.0% | 0.0% | △ |
| F12.10 | Reference 10 | -100.0~100.0% | 0.0% | △ |
| F12.11 | Reference 11 | -100.0~100.0% | 0.0% | △ |

| | | | | |
|-----------------|--|---|---------|---|
| F12.12 | Reference 12 | -100.0~100.0% | 0.0% | △ |
| F12.13 | Reference 13 | -100.0~100.0% | 0.0% | △ |
| F12.14 | Reference 14 | -100.0~100.0% | 0.0% | △ |
| F12.15 | Reference 15 | -100.0~100.0% | 0.0% | △ |
| F12.16 | Reference 0 source | 0: Digital setting (F12.00) | 0 | × |
| | | 1: keypad potentiometer | | |
| | | 2: AI1 | | |
| | | 3: Process PID output | | |
| | | 4: X7/HI pulse input | | |
| | | 5: AI2 | | |
| F12.17 | Running mode of simple PLC | 6: AI3 | 0000 | × |
| | | Unit's place: PLC running mode | | |
| | | 0: Stop after a single cycle | | |
| | | 1: Continue to run with the last frequency after a single cycle | | |
| | | 2: Repeat cycles | | |
| | | Ten's place: started mode | | |
| | | 0: Continue to run from the step of stop (or fault) | | |
| | | 1: Run from the first step "multi-step frequency 0" | | |
| | | 2: Run from the eighth step "multi-step frequency 8" | | |
| | | 3: Run from the fifteenth step "multi-step frequency 15" | | |
| | | Hundreds place: power loss memory | | |
| | | 0: Memory disabled on power loss | | |
| | | 1: Memory enabled on power loss | | |
| | | Thousands place: unit of simple PLC running time | | |
| 0: Second (s) | | | | |
| 1: Minute (min) | | | | |
| F12.18 | Running time of step 0 | 0.0~6000.0s(h) | 0.0s(h) | △ |
| F12.19 | Running time of step 1 | 0.0~6000.0s(h) | 0.0s(h) | △ |
| F12.20 | Running time of step 2 | 0.0~6000.0s(h) | 0.0s(h) | △ |
| F12.21 | Running time of step 3 | 0.0~6000.0s(h) | 0.0s(h) | △ |
| F12.22 | Running time of step 4 | 0.0~6000.0s(h) | 0.0s(h) | △ |
| F12.23 | Running time of step 5 | 0.0~6000.0s(h) | 0.0s(h) | △ |
| F12.24 | Running time of step 6 | 0.0~6000.0s(h) | 0.0s(h) | △ |
| F12.25 | Running time of step 7 | 0.0~6000.0s(h) | 0.0s(h) | △ |
| F12.26 | Running time of step 8 | 0.0~6000.0s(h) | 0.0s(h) | △ |
| F12.27 | Running time of step 9 | 0.0~6000.0s(h) | 0.0s(h) | △ |
| F12.28 | Running time of step 10 | 0.0~6000.0s(h) | 0.0s(h) | △ |
| F12.29 | Running time of step 11 | 0.0~6000.0s(h) | 0.0s(h) | △ |
| F12.30 | Running time of step 12 | 0.0~6000.0s(h) | 0.0s(h) | △ |
| F12.31 | Running time of step 13 | 0.0~6000.0s(h) | 0.0s(h) | △ |
| F12.32 | Running time of step 14 | 0.0~6000.0s(h) | 0.0s(h) | △ |
| F12.33 | Running time of step 15 | 0.0~6000.0s(h) | 0.0s(h) | △ |
| F12.34 | Acceleration/deceleration time of simple PLC reference 0 | 0~3 | 0 | △ |
| F12.35 | Acceleration/deceleration time of simple PLC | 0~3 | 0 | △ |

| | | | | |
|------------------------------|---|---|------|---|
| | reference 1 | | | |
| F12.36 | Acceleration/deceleration time of simple PLC reference 2 | 0~3 | 0 | △ |
| F12.37 | Acceleration/deceleration time of simple PLC reference 3 | 0~3 | 0 | △ |
| F12.38 | Acceleration/deceleration time of simple PLC reference 4 | 0~3 | 0 | △ |
| F12.39 | Acceleration/deceleration time of simple PLC reference 5 | 0~3 | 0 | △ |
| F12.40 | Acceleration/deceleration time of simple PLC reference 6 | 0~3 | 0 | △ |
| F12.41 | Acceleration/deceleration time of simple PLC reference 7 | 0~3 | 0 | △ |
| F12.42 | Acceleration/deceleration time of simple PLC reference 8 | 0~3 | 0 | △ |
| F12.43 | Acceleration/deceleration time of simple PLC reference 9 | 0~3 | 0 | △ |
| F12.44 | Acceleration/deceleration time of simple PLC reference 10 | 0~3 | 0 | △ |
| F12.45 | Acceleration/deceleration time of simple PLC reference 11 | 0~3 | 0 | △ |
| F12.46 | Acceleration/deceleration time of simple PLC reference 12 | 0~3 | 0 | △ |
| F12.47 | Acceleration/deceleration time of simple PLC reference 13 | 0~3 | 0 | △ |
| F12.48 | Acceleration/deceleration time of simple PLC reference 14 | 0~3 | 0 | △ |
| F12.49 | Acceleration/deceleration time of simple PLC reference 15 | 0~3 | 0 | △ |
| F12.50 | UP/DOWN function selection of Multi-reference | Unit's place: Action selection when power off 0: Zero clearing when power off 1: Hold when power off Ten's place: select if it can be reduced to negative 0: Disable 1: Enable | 00 | × |
| F12.51 | UP/DOWN speed of Multi-reference | 0.0~100.0% (0.0% Invalid) | 0.0% | △ |
| Group F13 Process PID | | | | |
| F13.00 | PID setting | 0: F13.01 digital setting 1: keypad potentiometer 2: AI1 | 0 | × |

| | | | | |
|--------|--------------------------------------|---|--------|---|
| | | 3: Communication | | |
| | | 4: Multi-Reference | | |
| | | 5: DI7/HI pulse input | | |
| | | 6: AI2 | | |
| | | 7: AI3 | | |
| F13.01 | PID digital setting | 0.0~100.0% | 50.0% | △ |
| F13.02 | PID feedback | 0: AI1 | 0 | × |
| | | 1: AI2 | | |
| | | 2: Communication | | |
| | | 3: AI1+AI2 | | |
| | | 4: AI1-AI2 | | |
| | | 5: Max{AI1, AI2} | | |
| | | 6: Min{AI1, AI2} | | |
| | | 7: DI7/HI pulse input | | |
| | | 8: AI3 | | |
| F13.03 | PID setting feedback range | 0.0~6000.0 | 100.0 | △ |
| F13.04 | PID action direction | 0: Forward action | 0 | × |
| | | 1: Reverse action | | |
| F13.05 | Filtering time of PID setting | 0.000~10.000s | 0.000s | △ |
| F13.06 | Filtering time of PID feedback | 0.000~10.000s | 0.000s | △ |
| F13.07 | Filtering time of PID output | 0.000~10.000s | 0.000s | △ |
| F13.08 | Proportional gain Kp1 | 0.0~100.0 | 1.0 | △ |
| F13.09 | Integration time Ti1 | 0.01~10.00s | 0.10s | △ |
| F13.10 | Differential time Td1 | 0.000~10.000s | 0.000s | △ |
| F13.11 | Proportional gain Kp2 | 0.0~100.0 | 1.0 | △ |
| F13.12 | Integration time Ti2 | 0.01~10.00s | 0.10s | △ |
| F13.13 | Differential time Td2 | 0.000~10.000s | 0.000s | △ |
| F13.14 | PID parameter switch | 0: No switch, determined by parameters Kp1, Ti1 and Td1 | 0 | × |
| | | 1: Auto switch on the basis of input offset | | |
| | | 2: Switched by terminal | | |
| F13.15 | PID parameter switchover deviation 1 | 0.0~100.0% | 20.0% | × |
| F13.16 | PID parameter switchover deviation 2 | 0.0~100.0% | 80.0% | × |
| F13.17 | PID offset limit | 0.0~100.0% | 0.0% | × |
| F13.18 | PID integral property | Unit's place (Whether to stop integral operation when the output reaches the limit) | 00 | × |
| | | 0: Continue integral operation | | |
| | | 1: Stop integral operation | | |
| | | Ten's place (Integral separated) | | |
| | | 0: Invalid | | |
| | | 1: Valid | | |
| F13.19 | PID differential limit | 0.0~100.0% | 0.5% | × |
| F13.20 | PID initial value | 0.0~100.0% | 0.0% | × |
| F13.21 | Holding time of PID initial value | 0.0~6000.0s | 0.0s | × |
| F13.22 | PID output frequency upper limit | PID output frequency lower limit~100.0% (100.0% corresponds to | 100.0% | × |

| | | | | |
|--|--|--|--------|---|
| | | maximum frequency) | | |
| F13.23 | PID output frequency lower limit | -100.0%~PID output frequency lower limit | 0.0% | × |
| F13.24 | Low value of PID feedback loss | 0.1~100.0% 0.0%: Not judging feedback loss | 0.0% | × |
| F13.25 | Detection time for low value of PID feedback loss | 0.0~30.0s | 1.0s | × |
| F13.26 | PID operation selection | Unit's place: PID operation selection when stop 0:Do not operate when stop 1:Operate when stop | 00000 | × |
| | | Ten's place: output is limited by output frequency 0:No limited 1:limited | | |
| | | Hundred's place: UP/DOWN digital given of PID 0:Zero clearing when power off 1:Hold when power off | | |
| | | Thousand's place: PID feedback loss detection when stop 0:Not detect when stop 1:detect when stop | | |
| | | Then thousand's place: action for PID feedback loss 0:Report fault 1:Ramp to stop | | |
| F13.27 | UP/DWON speed of PID digital given | 0.0~100.0% (0.0% Invalid) | 0.0% | △ |
| F13.28 | High value of PID feedback loss | 0.1~100.0% 0.0%: Not judging feedback loss | 100.0% | × |
| F13.29 | Detection time for high value of PID feedback loss | 0.0~30.0s | 1.0s | × |
| Group F14: Swing Frequency, Fixed Length , Wakeup and Count | | | | |
| F14.00 | Swing frequency setting mode | 0: Relative to the setting frequency | 0 | × |
| | | 1: Relative to the maximum frequency | | |
| F14.01 | Swing frequency amplitude | 0.0~100.0% | 0.0% | △ |
| F14.02 | Jump frequency amplitude | 0.0~50.0% | 0.0% | △ |
| F14.03 | Rising Time of Swing frequency | 0.0~6000.0s | 5.0s | △ |
| F14.04 | Dropping Time of Swing frequency | 0.0~6000.0s | 5.0s | △ |
| F14.05 | Set length | 0m~65535m | 1000m | × |
| F14.06 | Number of pulses per meter | 0.1~6553.5 | 100.0 | × |
| F14.07 | Command when the length attained | 0: Not stop | 0 | × |
| | | 1: Stop | | |
| F14.08 | Set count value | 1~65535 | 1000 | × |
| F14.09 | Designated count value | 1~65535 | 1000 | × |
| F14.10 | Wakeup frequency | Dormant frequency (F14.12)~Fmax | 0.00Hz | △ |
| F14.11 | Wakeup delay time | 0.0~6000.0s | 0.0s | △ |
| F14.12 | Dormant frequency | 0.00~Wakeup frequency | 0.00Hz | △ |

| | | | | |
|--|---|---|-------|---|
| F14.13 | Dormant delay time | 0.0~6000.0s | 0.0s | △ |
| F14.14 | Wake up mode selection | 0: Frequency | 0 | × |
| | | 1: Pressure | | |
| F14.15 | Dormancy mode selection | 0: Frequency | 0 | × |
| | | 1: Pressure | | |
| F14.16 | Voltage feedback source | Unit's place: pressure feedback 0: AI1 1: AI2 2: DI7/HI pulse input 3: AI3 | 0 | × |
| | | Ten's place: pressure dormancy mode 0: Positive direction, dormancy on big pressure and wakeup on small pressure 1: Negative direction, dormancy on small pressure and wakeup on big pressure | | |
| F14.17 | Wake up pressure | 0.0%~Dormancy pressure | 10.0% | △ |
| F14.18 | Dormancy pressure | Wake up pressure~100.0% | 50.0% | △ |
| Group F15: Communication Parameters | | | | |
| F15.00 | Baud rate | 0: 4800bps | 1 | × |
| | | 1: 9600bps | | |
| | | 2: 19200bps | | |
| | | 3: 38400bps | | |
| | | 4: 57600bps | | |
| | | 5: 115200bps | | |
| F15.01 | Data format | No check, data format (1-8-N-2) for RTU | 0 | × |
| | | 1: Even parity check, data format (1-8-E-1) for RTU | | |
| | | 2: Odd Parity check, data format (1-8-O-1) for RTU | | |
| | | 3: No check, data format(1-8-N-1) for RTU | | |
| F15.02 | Local address | 1~247 0: Broadcast address | 1 | × |
| F15.03 | Communication timeout | 0.0~60.0s | 0.0s | × |
| F15.04 | Response time delay | 0~200ms | 1ms | × |
| F15.05 | Master-slave Communication Mode | 0: The inverter is the slave | 0 | × |
| | | 1: The inverter is the master | | |
| F15.06 | The Master Communication Sending Data | 0: Set frequency | 0 | × |
| | | 1: Current running frequency | | |
| F15.07 | Message return when communication error | 0: No return | 1 | |
| | | 1: Return | | |
| F15.08 | U group return value | 0: Positive and negative | 0 | △ |
| | | 1: Absolute value | | |
| Group F16 Keys and Display of Keypad Parameters | | | | |
| F16.00 | MF.K key setting | 0: No function | 1 | × |
| | | 1: Jog | | |
| | | 2: Forward/reverse switchover | | |
| | | 3: Run command sources shifted | | |
| | | 4: Jog reverse | | |
| F16.01 | Keyboard operation display | Uni's digit: Function selection of | 001 | × |

| | | | | |
|--|--|--|--------|---|
| | | STOP/RESET key 0: stop function of STOP/RESET key is valid only in keyboard operation mode 1: Stop function of STOP/RES key is valid in any operation mode | | |
| | | Ten's digit: Speed display(U00.05) 0: According to the actual speed 1: Multiply frequency by speed coefficient(F16.11) | | |
| | | Hundred's digit: Decimal places 0: No decimal places 1: One decimal places 2: Two decimal places 3: Three decimal places | | |
| F16.02 | Keys locked option | 0: Not locked 1: Full locked 2: Keys locked other than RUN, STOP/RST 3: Keys locked other than STOP/RST 4: Keys locked other than >> | 0 | × |
| F16.03 | LED displayed parameters setting 1 on running status | 0~99(correspond U00.00~U00.99) | 0 | △ |
| F16.04 | LED displayed parameters setting 2 on running status | 0~99(correspond U00.00~U00.99) | 6 | △ |
| F16.05 | LED displayed parameters setting 3 on running status | 0~99(correspond U00.00~U00.99) | 3 | △ |
| F16.06 | LED displayed parameters setting 4 on running status | 0~99(correspond U00.00~U00.99) | 2 | △ |
| F16.07 | LED displayed parameters setting 1 on stop status | 0~99(correspond U00.00~U00.99) | 1 | △ |
| F16.08 | LED displayed parameters setting 2 on stop status | 0~99(correspond U00.00~U00.99) | 6 | △ |
| F16.09 | LED displayed parameters setting 3 on stop status | 0~99(correspond U00.00~U00.99) | 15 | △ |
| F16.10 | LED displayed parameters setting 4 on stop status | 0~99(correspond U00.00~U00.99) | 16 | △ |
| F16.11 | Speed display coefficient | 0.00~100.00 | 1.00 | △ |
| F16.12 | Power display coefficient | 0.0~300.0% | 100.0% | △ |
| F16.13 | The enable difference range of U00.00 and U00.01 | 0.00Hz~5.00Hz | 0.10Hz | △ |
| Group F17 User-defined Display Parameters | | | | |
| F17.00 | User-defined Display Parameter 0 | 00.00~49.99 | 00.03 | △ |
| F17.01 | User-defined Display Parameter 1 | 00.00~49.99 | 01.01 | △ |
| F17.02 | User-defined Display Parameter 2 | 00.00~49.99 | 01.02 | △ |
| F17.03 | User-defined Display Parameter 3 | 00.00~49.99 | 01.08 | △ |
| F17.04 | User-defined Display Parameter 4 | 00.00~49.99 | 01.09 | △ |
| F17.05 | User-defined Display Parameter 5 | 00.00~49.99 | 02.00 | △ |

| | | | | |
|----------------------------|---|----------------------------------|-------|---|
| F17.06 | User-defined Display Parameter 6 | 00.00~49.99 | 02.01 | △ |
| F17.07 | User-defined Display Parameter 7 | 00.00~49.99 | 02.12 | △ |
| F17.08 | User-defined Display Parameter 8 | 00.00~49.99 | 03.00 | △ |
| F17.09 | User-defined Display Parameter 9 | 00.00~49.99 | 03.01 | △ |
| F17.10 | User-defined Display Parameter 10 | 00.00~49.99 | 04.00 | △ |
| F17.11 | User-defined Display Parameter 11 | 00.00~49.99 | 04.01 | △ |
| F17.12 | User-defined Display Parameter 12 | 00.00~49.99 | 04.02 | △ |
| F17.13 | User-defined Display Parameter 13 | 00.00~49.99 | 04.03 | △ |
| F17.14 | User-defined Display Parameter 14 | 00.00~49.99 | 05.02 | △ |
| F17.15 | User-defined Display Parameter 15 | 00.00~49.99 | 08.01 | △ |
| F17.16 | User-defined Display Parameter 16 | 00.00~49.99 | 08.02 | △ |
| F17.17 | User-defined Display Parameter 17 | 00.00~49.99 | 08.03 | △ |
| F17.18 | User-defined Display Parameter 18 | 00.00~49.99 | 08.04 | △ |
| F17.19 | User-defined Display Parameter 19 | 00.00~49.99 | 08.05 | △ |
| F17.20 | User-defined Display Parameter 20 | 00.00~49.99 | 08.30 | △ |
| F17.21 | User-defined Display Parameter 21 | 00.00~49.99 | 11.10 | △ |
| F17.22 | User-defined Display Parameter 22 | 00.00~49.99 | 13.00 | △ |
| F17.23 | User-defined Display Parameter 23 | 00.00~49.99 | 13.01 | △ |
| F17.24 | User-defined Display Parameter 24 | 00.00~49.99 | 13.02 | △ |
| F17.25 | User-defined Display Parameter 25 | 00.00~49.99 | 13.08 | △ |
| F17.26 | User-defined Display Parameter 26 | 00.00~49.99 | 13.09 | △ |
| F17.27 | User-defined Display Parameter 27 | 00.00~49.99 | 00.00 | △ |
| F17.28 | User-defined Display Parameter 28 | 00.00~49.99 | 00.00 | △ |
| F17.29 | User-defined Display Parameter 29 | 00.00~49.99 | 00.00 | △ |
| F22Group:Virtual IO | | | | |
| F22.00 | Function selection of virtual VDI1 terminal | The same as function code F04.00 | 0 | × |
| F22.01 | Function selection of virtual VDI2 terminal | The same as function code F04.00 | 0 | × |
| F22.02 | Function selection of virtual VDI3 terminal | The same as function code F04.00 | 0 | × |
| F22.03 | Function selection of virtual VDI4 terminal | The same as function code F04.00 | 0 | × |

| | | | | |
|------------------------------------|---|--|--------|---|
| F22.04 | Function selection of virtual VDI5 terminal | The same as function code F04.00 | 0 | × |
| F22.05 | Valid status setting mode of virtual VDI terminals | (VDI5、VDI4、VDI3、VDI2、VDI1) | 00000 | × |
| | | 0: Validity of VDI depends on virtual VDOx's status | | |
| | | 1: Validity of VDI set by function code F22.06 | | |
| F22.06 | Settings of virtual VDI terminal status | (VDI5、VDI4、VDI3、VDI2、VDI1) | 00000 | △ |
| | | 0: Invalid | | |
| | | 1: Valid | | |
| F22.07 | Function selection of virtual VDO1 terminals output | 0 : Internal short circuited to physics Dlx Other: The same as function code F05.00 | 0 | △ |
| F22.08 | Function selection of virtual VDO2 terminals output | 0 : Internal short circuited to physics Dlx Other: The same as function code F05.00 | 0 | △ |
| F22.09 | Function selection of virtual VDO3 terminals output | 0 : Internal short circuited to physics Dlx Other: The same as function code F05.00 | 0 | △ |
| F22.10 | Function selection of virtual VDO4 terminals output | 0 : Internal short circuited to physics Dlx Other: The same as function code F05.00 | 0 | △ |
| F22.11 | Function selection of virtual VDO5 terminals output | 0 : Internal short circuited to physics Dlx Other: The same as function code F05.00 | 0 | △ |
| F22.12 | Virtual VDO1 output delay time | 0.0s~6000.0s | 0.0s | △ |
| F22.13 | Virtual VDO2 output delay time | 0.0s~6000.0s | 0.0s | △ |
| F22.14 | Virtual VDO3 output delay time | 0.0s~6000.0s | 0.0s | △ |
| F22.15 | Virtual VDO4 output delay time | 0.0s~6000.0s | 0.0s | △ |
| F22.16 | Virtual VDO5 output delay time | 0.0s~6000.0s | 0.0s | △ |
| F22.17 | VDO output terminal positive and negative logic | VDO5、VDO4、VDO3、VDO2、VDO1 | 00000 | △ |
| | | 0: Positive logic | | |
| | | 1: Negative logic | | |
| Group U00 Status Monitoring | | | | |
| U00.00 | Running frequency | 0.00~Fup | 0.00Hz | ⊙ |
| U00.01 | Set frequency | 0.00~Fmax | 0.00Hz | ⊙ |
| U00.02 | Output voltage | 0~660V | 0.0V | ⊙ |
| U00.03 | Output current | 0.0~3000.0A | 0.0A | ⊙ |
| U00.04 | Output power | -3000.0~3000.0kW | 0.0kW | ⊙ |
| U00.05 | Estimated Motor Speed | 0~60000rpm | 0rpm | ⊙ |
| U00.06 | Bus voltage | 0~1200V | 0V | ⊙ |
| U00.07 | Synchronous Frequency | 0.00~Fup | 0.00Hz | ⊙ |
| U00.08 | PLC step | 1~15 | 1 | ⊙ |

| | | | | |
|--------------------------|--|-----------------------------------|---------|---|
| U00.09 | Program Operation Time | 0.0~6000.0s(h) | 0.0s(h) | ⊙ |
| U00.10 | PID set | 0~60000 | 0 | ⊙ |
| U00.11 | PID feedback | 0~60000 | 0 | ⊙ |
| U00.12 | Status of DI1~DI5 digital input terminal | DI5 DI4 DI3 DI2 DI1 | 00000 | ⊙ |
| U00.13 | Status of DI6~DI7 digital input terminal | DI7 DI6 | 00 | ⊙ |
| U00.14 | Status of digital output terminal | R2 R1 Y2 Y1 | 0000 | ⊙ |
| U00.15 | AI1 input | 0.0~100.0% | 0.0% | ⊙ |
| U00.16 | AI2 input | 0.0~100.0% | 0.0% | ⊙ |
| U00.17 | AI3 input | -100.0~100.0% | 0.0% | ⊙ |
| U00.18 | Keypad potentiometer input | 0.0~100.0% | 0.0% | ⊙ |
| U00.19 | HI input | 0.00~100.00kHz | 0.00kHz | ⊙ |
| U00.20 | AO1 output | 0.0~100.0% | 0.0% | ⊙ |
| U00.21 | AO2 output | 0.0~100.0% | 0.0% | ⊙ |
| U00.22 | HO output | 0.00~100.00kHz | 0.00kHz | ⊙ |
| U00.23 | Temperature of inverter | -40.0 °C120.0 °C | 0.0 °C | ⊙ |
| U00.24 | Accumulative power-on time | 0~65535min | 0min | ⊙ |
| U00.25 | Accumulative running time | 0~6553.5min | 0.0min | ⊙ |
| U00.26 | Cumulative power-on time | 0~65535h | 0h | ⊙ |
| U00.27 | Cumulative running time | 0~65535h | 0h | ⊙ |
| U00.28 | Count value | 0~65535 | 0 | ⊙ |
| U00.29 | Length value | 0~65535m | 0m | ⊙ |
| U00.30 | Linear speed | 0~65535m/min | 0m/Min | |
| U00.31 | Output torque | 0.0~300.0% | 0.0% | ⊙ |
| U00.32 | PTC motor temperature detection | -40 °C200 °C | 0 °C | ⊙ |
| U00.33 | Speed that detected by encoder | 0~60000rpm | 0rpm | ⊙ |
| U00.34 | Monitoring of encoder line number | 0~65535 | 0 | ⊙ |
| U00.35 | Power consumption | 0~65535kWh | 0kWh | ⊙ |
| U00.36 | VDI1~VDI5 input status | VDI5 VDI4 VDI3 VDI2 VDI1 | 00000 | ⊙ |
| U00.37 | VDO1~VDO5output status | VDO5 VDO4 VDO3 VDO2 VDO1 | 00000 | ⊙ |
| Group U01 Fault Record | | | | |
| U01.00 | Code of the latest fault | Err00: No fault | 0 | ⊙ |
| | | Err01: Accel overcurrent | | |
| | | Err02: Decel overcurrent | | |
| | | Err03: Constant-speed overcurrent | | |
| | | Err04: Accel overvoltage | | |
| | | Err05: Decel overvoltage | | |
| | | Err06: Constant-speed overvoltage | | |
| | | Err07: Bus undervoltage | | |
| | | Err08: Short circuit | | |
| | | Err09: Power input phase loss | | |
| | | Err10: Power output phase loss | | |
| | | Err11: Motor overload | | |
| Err12: Inverter overload | | | | |

| | | | | |
|--------|--|---|--------|---|
| | | Err13: External equipment fault | | |
| | | Err14: Module overheat | | |
| | | Err15: EEPROM read/write fault | | |
| | | Err16: Motor auto-tuning cancelled | | |
| | | Err17: Motor auto-tuning fault | | |
| | | Err18: Communication overtime Error | | |
| | | Err19: PID feedback loss | | |
| | | Err20: Continuous running time Reached | | |
| | | Err21: Parameter upload fault | | |
| | | Err22: Parameter download fault | | |
| | | Err23: Braking unit fault | | |
| | | Err24: Module temperature detection disconnection | | |
| | | Err25: Load becoming 0 | | |
| | | Err26: With-wave current limit fault | | |
| | | Err27: Inverter soft-start relay is off | | |
| | | Err28: EEPROM version is not compatible | | |
| | | Err29: Instantaneous overcurrent | | |
| | | Err30: Instantaneous overvoltage | | |
| | | Err39: PTC motor temperature too high | | |
| | | Err40: Setting operation time ends | | |
| U01.01 | Running frequency when the latest fault occurred | 0.00~Fup | 0.00Hz | ⊖ |
| U01.02 | Output current when the latest fault occurred | 0.0~3000.0A | 0.0A | ⊖ |
| U01.03 | Bus voltage when the latest fault occurred | 0~1200V | 0V | ⊖ |
| U01.04 | Cumulative running time when the latest fault occurred | 0~65535h | 0h | ⊖ |
| U01.05 | Code of previous fault | Same as U01.00 | 0 | ⊖ |
| U01.06 | Running frequency when previous fault occurred | 0.00~Fup | 0.00Hz | ⊖ |
| U01.07 | Output current when previous fault occurred | 0.0~3000.0A | 0.0A | ⊖ |
| U01.08 | Bus voltage when previous fault occurred | 0~1200V | 0V | ⊖ |
| U01.09 | Cumulative running time when previous fault occurred | 0~65535h | 0h | ⊖ |
| U01.10 | Before-previous fault code | Same as U01.00 | 0 | ⊖ |
| U01.11 | Running frequency when before-previous fault occurred | 0.00~Fup | 0.00Hz | ⊖ |
| U01.12 | Output current when before-previous fault occurred | 0.0~3000.0A | 0.0A | ⊖ |
| U01.13 | Bus voltage when before-previous fault occurred | 0~1200V | 0V | ⊖ |

| | | | | |
|--------|---|----------------------|-------|---|
| U01.14 | Cumulative running time when before-previous fault occurred | 0~65535h | 0h | ⊙ |
| U01.15 | Previous 3 categories of faults | The same with U01.00 | Err00 | ⊙ |
| U01.16 | Previous 4 categories of faults | The same with U01.00 | Err00 | ⊙ |
| U01.17 | Previous 5 categories of faults | The same with U01.00 | Err00 | ⊙ |
| U01.18 | Previous 6 categories of faults | The same with U01.00 | Err00 | ⊙ |
| U01.19 | Previous 7 categories of faults | The same with U01.00 | Err00 | ⊙ |
| U01.20 | Previous 8 categories of faults | The same with U01.00 | Err00 | ⊙ |
| U01.21 | Previous 9 categories of faults | The same with U01.00 | Err00 | ⊙ |
| U01.22 | Previous 10 categories of faults | The same with U01.00 | Err00 | ⊙ |
| U01.23 | Previous 11 categories of faults | The same with U01.00 | Err00 | ⊙ |
| U01.24 | Previous 12 categories of faults | The same with U01.00 | Err00 | ⊙ |
| U01.25 | Previous 13 categories of faults | The same with U01.00 | Err00 | ⊙ |

Chapter 6 Specification of Parameters

Group F00 System Parameters

| | | | |
|--------|--------------------------|----------------|------------|
| F00.00 | Setting of user password | Range: 0~65535 | Default: 0 |
|--------|--------------------------|----------------|------------|

Setting of password:

A number greater than 100 could be set as a user password by entering this password into F00.00 and pressing ENT key to confirm once, the password setting will take effect as long as there is no operation on keypad within 2 minutes, or cutting the power off and power up again. After a password has been set and taken effect, you must enter the correct password in order to enter the menu. If the entered password is incorrect you cannot view or modify parameters.

Change password:

Access F00.00 after entering the original password (at this point, F00.00 displays setting of user password) and set the new password following the above-noted procedure.

Password clearance:

Access F00.00 after entering the original password (at this point, F00.00 displays setting of user password); F00.00 is set to 0 and press ENT key to make confirmation. In this way, password is successfully cleared and the password protection function is disabled.

| | | | |
|--------|-----------------------|------------|------------|
| F00.01 | Display of parameters | Range: 0~2 | Default: 0 |
|--------|-----------------------|------------|------------|

0: Display all parameters

1: Only display F00.00, F00.01 and user-defined parameters

2: Only display F00.00, F00.01 and the parameters different with factory default

| | | | |
|--------|----------------------|------------|------------|
| F00.02 | Parameter protection | Range: 0~1 | Default: 0 |
|--------|----------------------|------------|------------|

0: All parameter programming allowed

1: Only this parameter programming allowed

| | | | |
|--------|--------------------------|-----------|------------|
| F00.04 | Parameter initialization | Range:0~6 | Default: 0 |
|--------|--------------------------|-----------|------------|

0: No operation

1: Restore all parameters to factory default (excluding motor parameters)

If F00.04 is set to 1, most function codes are restored to the default settings except motor parameters, fault records, accumulative running time, and accumulative power-on time.

2: Clear fault record

If F00.04 is set to 2, all fault record of Group U01 will be cleared.

3: Back up current user parameters

If F00.04 is set to 3, the current parameter settings are backed up, helping you to restore the setting if incorrect parameter setting is performed.

4: Restore all parameters to backup parameters

If F00.04 is set to 4, the previous backup user parameters are restored.

5: Restore factory default (include motor parameters)

The same as function 1, but this include motor parameters

6: Power consumption zero clearing

After setting F00.04 as 6, U00.35 parameter cleared to zero

| | | | |
|--------|-------------------|-----------|------------|
| F00.05 | Copy of parameter | Range:0~3 | Default: 0 |
|--------|-------------------|-----------|------------|

0: No operation

1: Upload all parameters other than Group U to UP/DOWNLOAD

2: Download all parameters of UP/DOWNLOAD other than F08~F09 to drive

3: Download all parameters of UP/DOWNLOAD to drive

*: UP/DOWNLOAD is optional parts

| | | | |
|--------|------------------------|-----------|------------|
| F00.06 | Parameter editing mode | Range:0~2 | Default: 0 |
|--------|------------------------|-----------|------------|

0: Editable via keypad and RS485

1: Editable via keypad

2: Editable via RS485

| | | | |
|--------|----------------------|-----------|-----------|
| F00.08 | Motor 1 control mode | Range:0~2 | Default:1 |
|--------|----------------------|-----------|-----------|

0: V/f control

Constant voltage&frequency ratio control. Applicable to such cases in which the performance

Requirement to the drive is not rigorous, or using one drive to drive several motors, or it is difficult to identify motor parameters correctly, etc. When motor 1 under V/f control is selected, need to set related parameters Group F09 well.

1: Sensor-less vector control 1

This helps achieve high-performance control without encoder and provides strong adaptability of load. Under this selection, please correctly set parameters Group F08 and F09.

2: Sensor-less vector control 2

This helps achieve high-performance control without encoder. This control technique is superior to sensor-less vector control 1. Under this selection, please correctly set motor parameters of Group F08 and vector control parameters of Group F10.

| | | | |
|--------|-------------------|-----------|------------|
| F00.09 | DI7/HI input mode | Range:0~1 | Default: 0 |
|--------|-------------------|-----------|------------|

0: Digital input terminal 7

1: Pulse input

| | | | |
|--------|------------------------|---------------|------------|
| F00.10 | AI1/AI2/AI3 input mode | Range:000~111 | Default: 0 |
|--------|------------------------|---------------|------------|

Unit's place: AI1

0: Analog input

1: Digital input

Decade: AI2 (same as AI1)

Hundreds place: AI3 (same as AI1)

| | | | |
|--------|------------------|-----------|------------|
| F00.11 | Y2/HO input mode | Range:0~1 | Default: 0 |
|--------|------------------|-----------|------------|

0: Digital Output terminal 2

1: Pulse output

| | | | |
|--------|------------------|---------------|-------------|
| F00.12 | PWM optimization | Range:000~123 | Default:000 |
|--------|------------------|---------------|-------------|

Unit's place: PWM modulation mode

0: Fixed carrier

Carrier of inverter is a fixed value set by F00.13.

1: Random carrier

Inverter carrier will vary with output frequency in linear variation. Upper/Lower carrier frequencies are under control of F00.14 and F00.15.

2: Derating of fixed carrier

Inverter can adjust carrier value based on F00.12, carrier temperature and carrier current, protecting itself against overtemperature.

3: Derating of random carrier

Inverter can adjust carrier value based on random carrier, carrier temperature and carrier current, protecting itself against overtemperature.

Decade: PWM modulation mode

0: Seven-segment mode

1: Five-segment mode

2: Five-segment and seven-segment automatic switchover

This selection is valid only for V/f control. When five-segment mode is selected, the drive has low temperature rise but relatively higher output current harmonic. Under seven-segment mode, it has relatively higher temperature rise but lower output current harmonic. Under SVC pattern, PWM is seven-segment mode.

Hundreds place: over-modulation adjustment

0: Disabled

1: Enabled

At low grid voltage or long-term heavy-duty operation, over-modulation can improve the voltage utilization and enhance the maximum voltage output capacity of the drive. This parameter takes effect only for V/f control, while over-modulation is enabled all the time under SVC pattern.

| | | | |
|--------|-------------------|-----------------------|------------------------|
| F00.13 | Carrier frequency | Range:0.700~16.000kHz | Default: Model defined |
|--------|-------------------|-----------------------|------------------------|

At lower carrier frequency, output current of the drive produces higher harmonics, motor loss increases, and temperature and motor noise rise, but drive temperature, drive leakage current, and drive interference to external devices are lower or less.

With higher carrier frequency, drive temperature will rise, drive leakage current is bigger, and drive interference to external devices is bigger. However, motor loss and noise will be lower, and motor temperature will drop.

The table below specifies the setting range and factory default of PWM carrier frequency of the drives at different power ratings:

| Power rating of the inverter | Range | Default |
|------------------------------|----------------|---------|
| ≤15kW | 0.700k~16.000k | 4.000k |
| 18.5kW~45kW | 0.700k~8.000k | 4.000k |
| 55kW~75kW | 0.700k~6.000k | 3.000k |
| ≥90kW | 0.700k~3.000k | 2.000k |

PWM carrier frequency setting method:

- 1) When the motor line is too long, reduce carrier frequency.
- 2) When torque at low speed is unstable, reduce carrier frequency.
- 3) If the drive produces severe interference to surrounding equipment, reduce carrier frequency.
- 4) Leakage current of the drive is big, reduce carrier frequency.
- 5) Drive temperature rise is relatively high, reduce carrier frequency.
- 6) Motor temperature rise is relatively high, increase carrier frequency.
- 7) Motor noise is relatively big, increase carrier frequency.

ATTENTION:

Increasing carrier frequency can reduce motor noise and heat, but it will increase temperature of inverter. When the carrier frequency is higher than the default, inverter rated power shall be decreased by 5% for every additional 1 kHz carrier frequency.

| | | | |
|--------|-------------------------|-----------------------|-------------------|
| F00.14 | Upper carrier frequency | Range:0.700~16.000kHz | Default:8.000 kHz |
| F00.15 | Lower carrier frequency | Range:0.700~16.000kHz | Default:2.000 kHz |

Inverter carrier will vary with output frequency in linear variation. Upper/Lower carrier frequencies are under control of F00.14 and F00.15.

| | | | |
|--------|----------------|------------------|----------------|
| F00.16 | Output voltage | Range:5.0~150.0% | Default:150.0% |
|--------|----------------|------------------|----------------|

Adjust the percentage of output voltage to input voltage.

| | | | |
|--------|-----|-----------|------------|
| F00.17 | AVR | Range:0~2 | Default: 1 |
|--------|-----|-----------|------------|

0: Disabled

1: Always be valid

Output voltage of inverter adjust automatically according to fluctuation of the bus voltage, to keep output voltage constant.

2: Invalid when deceleration

AVR is invalid in the process of deceleration.

| | | | |
|--------|-------------|-----------|-----------|
| F00.18 | Fan control | Range:0~1 | Default:1 |
|--------|-------------|-----------|-----------|

After power is on, the fan runs per the control mode after running for 2 minutes regardless of the working status of inverter.

0: The fan runs directly after inverter is power-on.

1: the fan works when the AC drive is in running state. When the AC drive stops, the cooling fan works if the heat sink temperature is higher than 42°C, and stops working if the heat sink temperature is lower than 38°C.

| | | | |
|--------|------------------|---------------|------------|
| F00.19 | Factory password | Range:0~65535 | Default: 0 |
|--------|------------------|---------------|------------|

Factory parameter

| | | | |
|--------|------------------------|--------------------|------------------------|
| F00.20 | Inverter rated power | Range:0.2~1000.0kW | Default: Model defined |
| F00.21 | Inverter rated voltage | Range:220~380V | Default: Model defined |
| F00.22 | Inverter rated current | Range:0.1~1500.0A | Default: Model defined |
| F00.23 | Software version | Range:0.01~99.99 | Default: Model defined |

The parameters are only for reference and cannot be edited.

| | | | |
|--------|------------------------|-----------------------------|------------|
| F00.24 | Dealer password | Range: 0~65535 | Default: 0 |
| F00.25 | Setting operation time | Range: 0~65535h(0: Invalid) | Default: 0 |

When total running time ≥F00.25, inverter will not work. When setting F00.24, need to unlock F00.24 dealer passport, after time setting, need to input dealer passport to lock.

★: Setting this parameter may cause that the inverter can't work normally, please set carefully.

Group F01 Frequency command

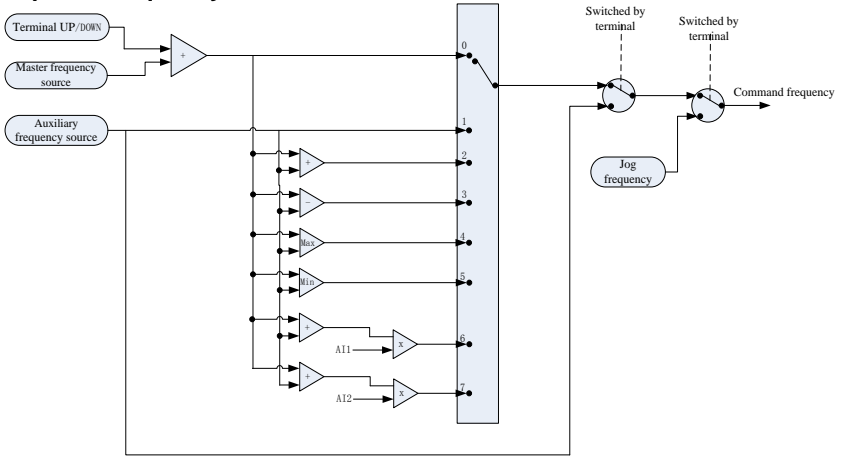

Fig. 6-1

| | | | |
|--------|----------------------------|-----------|------------|
| F01.00 | Frequency source selection | Range:0~7 | Default: 0 |
|--------|----------------------------|-----------|------------|

0: Master frequency source

The frequency source is determined by master frequency source F01.01.

1: Auxiliary frequency source

The frequency source is determined by auxiliary frequency source F01.03.

2: Master + Auxiliary

The frequency source is determined by Master + Auxiliary.

3: Master - Auxiliary

The frequency source is determined by Master - Auxiliary.

4: MAX {Master, Auxiliary}

The frequency source is determined by MAX {Master, Auxiliary}.

5: MIN {Master, Auxiliary}

The frequency source is determined by MIN {Master, Auxiliary}.

6: AI1(Master + Auxiliary)

The frequency source is determined by AI1*(Master + Auxiliary).

7: AI2(Master + Auxiliary)

The frequency source is determined by AI2*(Master + Auxiliary).

| | | | |
|--------|-----------------------------------|-----------|-----------|
| F01.01 | Master frequency source selection | Range:0~9 | Default:1 |
|--------|-----------------------------------|-----------|-----------|

0: Digital setting (F01.02)

When the inverter is powered on, the value of F01.02 is taken as the master frequency source.

1: Keypad potentiometer

2: Analog input AI1

AI1 and AI2 are (0~10V) voltage input and (0~20mA) current input programmable. Voltage or current input can be selected through toggle switches AI1 and AI2 on control board.

When using external voltage/current analog input to the drive, the connection diagram is shown as Fig. 6-2:

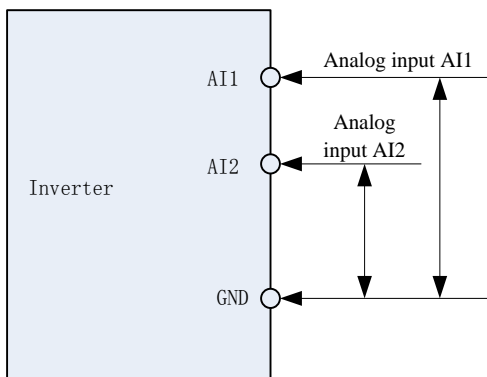

Fig. 6-2

If 10V power supply inside the drive is used with potentiometer, the connection diagram is shown as Fig. 6-3. Note that the toggle switch should be switched to voltage input side.

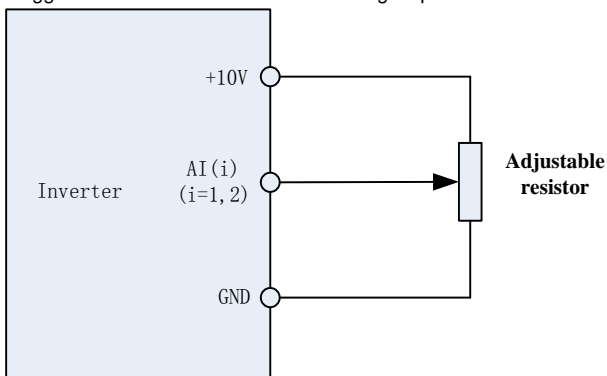

Fig. 6-3

3: Communication

Upper computer is the master frequency command source of the drive through standard RS485 communication interface on the drive. Refer to Group F15 and appendix on this manual for further information about communication protocol, and programming, etc.

4: Multi-reference

In multi-reference mode, combinations of different DI terminal states correspond to different set frequencies. The FR200 supports a maximum of 16 speeds implemented by 16 state combinations of four DI terminals (allocated with functions 13 to 16) in Group F04. The multiple references indicate percentages of the value of F01.08 (Maximum frequency).

If a DI terminal is used for the multi-reference function, you need to perform related setting in group F04.

5: PLC

Master frequency command is determined by simple PLC. See parameter Group F12 for details.

6: Process PID output

Master frequency command is determined by process closed-loop PID computation result. See parameter Group F13 for details.

7: DI7/HI pulse input

If this parameter value selected, command frequency will be determined by pulse frequency input via terminal DI7/HI only. In such a case, F00.09 should be set to 1. Corresponding relation between pulse frequency and command frequency is specified in F06.32~F06.35.

8: AI2

Master frequency command is determined by analog input AI2.

9: AI3

Master frequency command is determined by analog input AI3.

| | | | |
|--------|-------------------------------------|-------------------|-----------------|
| F01.02 | Digital setting of master frequency | Range:0.00~FmaxHz | Default:50.00Hz |
|--------|-------------------------------------|-------------------|-----------------|

When master frequency source selection F01.01 is set to 1, this parameter value will be the initial value of master frequency command.

| | | | |
|--------|------------------------------------|-----------|------------|
| F01.03 | Auxiliary frequency command source | Range:0~9 | Default: 0 |
|--------|------------------------------------|-----------|------------|

0: Digital setting (F01.04)

When the inverter is powered on, the value of F01.02 is taken as the master frequency source.

1: Keypad potentiometer

Auxiliary frequency command is determined by keypad potentiometer.

2: Analog input AI1

Auxiliary frequency command is determined by analog input AI1.

3: Communication

Upper computer is the auxiliary frequency command source of the drive through standard RS485 communication interface on the drive.

4: Multi-reference

Auxiliary frequency command is determined by multi-reference. See parameter Group F04 for details.

5: PLC

Auxiliary frequency command is determined by simple PLC. See parameter Group F12 for details.

6: Process PID output

Auxiliary frequency command is determined by process PID computation result. See parameter Group F13 for details.

7: DI7/HI pulse input

Auxiliary frequency command is determined by DI7/HI pulse input.

8: AI2

Auxiliary frequency command is determined by analog input AI2.

9: AI3

Auxiliary frequency command is determined by analog input AI3.

| | | | |
|--------|--|-----------------|-----------------|
| F01.04 | Digital setting of auxiliary frequency | Range:0.00~Fmax | Default:50.00Hz |
|--------|--|-----------------|-----------------|

When auxiliary frequency command F01.03 is set to 0, this parameter value should be the initial value of auxiliary frequency command.

| | | | |
|--------|------------------------------|-----------|------------|
| F01.05 | Range of auxiliary frequency | Range:0~1 | Default: 0 |
|--------|------------------------------|-----------|------------|

0: Relative to maximum frequency

1: Relative to master frequency

See F01.06 specification for details.

| | | | |
|--------|------------------------------|------------------|----------------|
| F01.06 | Coeff of auxiliary frequency | Range:0.0~150.0% | Default:100.0% |
|--------|------------------------------|------------------|----------------|

F01.05 and F01.06 will determine the final output value of auxiliary frequency command.

When F01.05 is set to 0 (relative to maximum frequency):

The auxiliary frequency = the auxiliary frequency F01.06.

When F01.05 is set to 1 (relative to master frequency):

The setting range of the auxiliary frequency varies according to the master frequency.

The auxiliary frequency = the auxiliary frequency F01.06

| | | | |
|--------|---------------|-----------------|----------------|
| F01.07 | Jog frequency | Range:0.00~Fmax | Default:5.00Hz |
|--------|---------------|-----------------|----------------|

This parameter sets the running frequency during jog.

| | | | |
|--------|-------------------|--------------------|-----------------|
| F01.08 | Maximum frequency | Range:20.00~600.00 | Default:50.00Hz |
|--------|-------------------|--------------------|-----------------|

Maximum frequency of F01.08 is the maximum allowable output frequency of drive.

| | | | |
|--------|-----------------------|------------------|-----------------|
| F01.09 | Upper limit frequency | Range:Fdown~Fmax | Default:50.00Hz |
|--------|-----------------------|------------------|-----------------|

| | | | |
|--------|-----------------------|----------------|----------------|
| F01.10 | Lower limit frequency | Range:0.00~Fup | Default:0.00Hz |
|--------|-----------------------|----------------|----------------|

F01.09 upper limit frequency is the user-defined maximum allowable running frequency; F01.10 lower limit frequency is user-defined minimum allowable running frequency.

ATTENTION:

1. Fup and Fdown shall be set as per motor nameplate parameters and working conditions. Motor shall not work in low frequency for a long time. Otherwise, motor service lifespan will be shortened due

to overheating.

2. Correlation of Fmax, Fup and Fdown: $0.00\text{Hz} \leq F_{\text{down}} \leq F_{\text{up}} \leq F_{\text{max}} \leq 600.00\text{Hz}$

| | | | |
|--------|---|-------------------|--------------|
| F01.11 | Operation when command frequency lower than lower limit frequency | Range:0~1 | Default: 0 |
| F01.12 | Lower limit frequency running time | Range:0.0~6000.0s | Default:0.0s |

0: Run at lower limit frequency

In case command frequency is lower than lower limit frequency, the running should be at lower limit frequency.

1: Run at 0 Hz would be activated after the time delay

If frequency command is lower than lower limit frequency, run at 0 Hz would be activated after the time delay set by F01.12. When lower limit frequency is 0, this limitation is invalid.

| | | | |
|--------|--|----------------------|------------------|
| F01.13 | Up to this frequency, start frequency compensation | Range: 0.00~600.00Hz | Default: 50.00Hz |
| F01.14 | Frequency compensation per 50Hz | Range: 0.00~50.00Hz | Default: 0.00Hz |

When frequency exceeded the value set by function code F01.13,output frequency will scale up the values that set by F01.14 for each exceeding 50Hz

Group F02 Start/Stop Control Start/Stop Control

| | | | |
|--------|-------------|-----------|------------|
| F02.00 | Run command | Range:0~2 | Default: 0 |
|--------|-------------|-----------|------------|

This parameter sets run command source. Run commands include "start, stop, forward , reverse, jog", etc.

0: Keypad control (LED off)

Control run command through RUN, STOP/RESET and MF.K keys on keypad (set multifunction key MF.K to JOG by F16.00). Refer to Chapter 4 about the operation of keypad.

1: Terminal control (LED on)

Controls run command via DI terminals. Perform FORWARD and REVERSE by DI terminals. The control modes are two-wire mode and three-wire mode selectable. See Group F04 for details of designation and wiring regulation of DI terminals.

2: Communication control (LED blinking)

Master device is able to control run command through built-in RS485 serial communication interface of drive. Refer to parameters Group F15 and appendix for further information about programming.

Run command from keypad, terminals and communication can be switched by terminals "run command switched to keypad control", "run command switched to terminal control" and "run command switched to communication control".

Multifunction key MF.K can be set to "run command sources shifted" key through parameter F16.00. When MF key is pressed under this setting; run command will be shifted during keypad control, terminal control and communication control circularly.

| | | | |
|--------|-------------------|-----------|------------|
| F02.01 | Running direction | Range:0~1 | Default: 0 |
|--------|-------------------|-----------|------------|

0: Forward

1: Reverse

You can change the rotation direction of the motor just by modifying this parameter without changing the motor wiring. Modifying this parameter is equivalent to exchanging any two of the motor's U, V, W wires.

Note:

The motor will resume running in the original direction after parameter initialization. Do not use this function in applications where changing the rotating direction of the motor is prohibited after system commissioning is complete.

| | | | |
|--------|----------------------|-----------|------------|
| F02.02 | Reverse-proof action | Range:0~1 | Default: 0 |
|--------|----------------------|-----------|------------|

0: Reverse enabled

1: Reverse disabled

In some applications, reverse is likely to result in equipment damage. This parameter is used to prevent reverse running.

| | | | |
|--------|--------------------------|-------------------|--------------|
| F02.03 | Dead time of forward and | Range:0.0~6000.0s | Default:0.0s |
|--------|--------------------------|-------------------|--------------|

| | | | |
|--|---------|--|--|
| | reverse | | |
|--|---------|--|--|

The dead time with 0Hz output during the transition from forward to reverse, or from reverse to forward. As shown in Fig. 6-4.

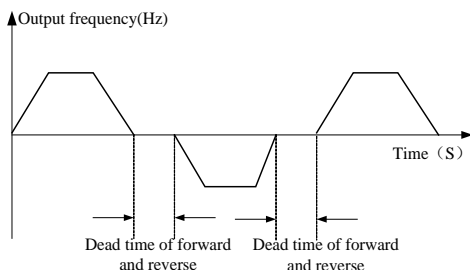

Fig. 6-4

| | | | |
|--------|------------|---------------|--------------|
| F02.04 | Start mode | Range:000~111 | Default: 000 |
|--------|------------|---------------|--------------|

Unit's place:

0: From start frequency

If the DC braking time (F02.08) is set to 0, the AC drive starts to run at the startup frequency(F02.05) and keeps this frequency for a period of time set by F02.06, and then accelerated to command frequency in accordance with the accel method and time..

If the DC braking time (F02.08) is not 0, the AC drive performs DC braking first and then starts to run at the startup frequency. It is applicable to small-inertia load application where the motor is likely to rotate at startup.

1: Rotational speed tracking restart

The AC drive judges the rotational speed and direction of the motor first and then starts at the tracked frequency. Such smooth start has no impact on the rotating motor. It is applicable to the restart upon instantaneous power failure of large-inertia load. To ensure the performance of rotational speed tracking restart, set the motor parameters correctly.

Ten's digit: Grounding short circuit detection

0: No grounding short circuit detection

No grounding short circuit detection

1: Grounding shourt-circuit detection before the first start

After inverter power on,when first time received running command,before running, inverter automatically starts grounding short-circuit detection on output terminal,if there are short circuit faults between inverter's output terminal and ground,inverter will alarm Err44 fault.

2: Grounding short-circuit detection before each start

Inverter automatically starts grounding short circuit detection on output terminal before each start,if there are short circuit faults between output terminal of inverter an ground,inverter will alarm Err44 fault.

Hundred's digit: Track direction

0: Track from zero speed

Under the speed tracking restart mode, when start, inverter track the current speed of motor slowly from zero to max frequency

1: Track from max frequency

Under the speed tracking restart mode,when start,inverter track current speed of motor slowly from max frequency to zero

Thousand's digit: Jog command firstly act

0:When normal start and Jog start command comes simultaneously, normal start act firstly;

1:When normal start and Jog start command comes simultaneously, Jog start act firstly;

| | | | |
|--------|--------------------------------|--------------------|----------------|
| F02.05 | Start frequency | Range:0.00~10.00Hz | Default:0.00Hz |
| F02.06 | Startup frequency holding time | Range:0.0~100.0s | Default:0.0s |

To ensure the motor torque at AC drive startup, set a proper startup frequency. In addition, to build excitation when the motor starts up, the startup frequency must be held for a certain period.

The startup frequency (F02.05) is not restricted by the frequency lower limit. If the set target frequency is lower than the startup frequency, the AC drive will not start and stays in the standby state.

During switchover between forward rotation and reverse rotation, the startup frequency holding time is disabled. The holding time is not included in the acceleration time but in the running time of simple PLC.

| | | | |
|--------|----------------------------|------------------|-------------|
| F02.07 | Startup DC braking current | Range:0.0~150.0% | Default:0.0 |
| F02.08 | Startup DC braking time | Range:0.0~100.0s | Default:0.0 |

Startup DC braking is generally used during restart of the AC drive after the rotating motor stops. Pre-excitation is used to make the AC drive build magnetic field for the asynchronous motor before startup to improve the responsiveness.

Startup DC braking is valid only for direct start (f02.05 = 0). In this case, the AC drive performs DC braking at the set startup DC braking current. After the startup DC braking time, the AC drives starts to run. If the startup DC braking time is 0, the AC drives starts directly without DC braking. The larger the startup DC braking current is, the larger the braking force is.

| | | | |
|--------|----------------------|-----------------|----------------|
| F02.09 | Speed search current | Range:0.0~180.0 | Default:130.0% |
|--------|----------------------|-----------------|----------------|

100% corresponds to rated current of the drive. When output current of drive is less than this parameter value, it will be deemed that the output frequency of drive has been kept in step with motor speed and the search action finished.

| | | | |
|--------|------------------------|----------------|--------------|
| F02.10 | Sped search decel time | Range:0.0~10.0 | Default:1.0s |
|--------|------------------------|----------------|--------------|

This parameter sets the output frequency Decel time of speed search action. This time means the time required for Decel from maximum frequency to 0. The shorter the speed search Decel time is, the faster the search will be. However, excessively rapid search may bring about inaccuracy of search result.

| | | | |
|--------|-------------------------|-----------------|--------------|
| F02.11 | Sped search coefficient | Range:0.01~5.00 | Default:0.30 |
|--------|-------------------------|-----------------|--------------|

Sped search coefficient

| | | | |
|--------|-------------|-----------|------------|
| F02.12 | Stop method | Range:0~1 | Default: 0 |
|--------|-------------|-----------|------------|

0: Ramp to stop

Upon the receipt of stop command, drive will gradually decrease output frequency according to the set Decel time, and stop when frequency attains 0.

1: Coast to stop

Upon the receipt of stop command, drive will immediately lock the output and the motor will stop with its mechanical inertia.

| | | | |
|--------|--------------------------------------|--------------------|----------------|
| F02.13 | Initial frequency of stop DC braking | Range:0.00~50.00Hz | Default:2.00Hz |
| F02.14 | Stop DC braking current | Range:0.0~150.0% | Default:0.0% |
| F02.15 | Waiting time of stop DC braking | Range:0.0~30.0s | Default:0.0s |
| F02.16 | Stop DC braking time | Range:0.0~30.0s | Default:0.0s |

Initial frequency of stop DC braking:

During the process of decelerating to stop, the AC drive starts DC braking when the running frequency is lower than the value set in F02.13.

Stop DC braking current:

This parameter specifies the output current at DC braking and is a percentage relative to the base value.

If the rated motor current is less than or equal to 80% of the rated AC drive current, the base value is the rated motor current.

If the rated motor current is greater than 80% of the rated AC drive current, the base value is 80% of the rated AC drive current.

Waiting time of stop DC braking:

When the running frequency decreases to the initial frequency of stop DC braking, the AC drive stops output for a certain period and then starts DC braking. This prevents faults such as over current caused due to DC braking at high speed.

Stop DC braking time:

This parameter specifies the holding time of DC braking. If it is set to 0, DC braking is cancelled.

ATTENTION:

If there is a DC brake signal of external terminal at stop, then the DC brake time takes the bigger value between the active time of the terminal and the setting time of F02.16.

The stop DC braking process is shown in the following figure.

Figure 6-5 Stop DC braking process

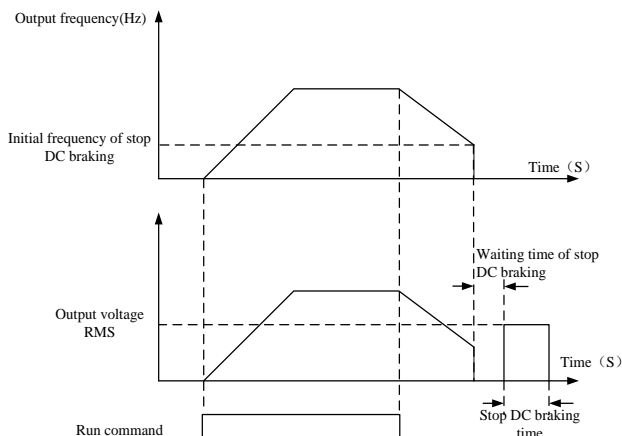

Fig. 6-5

| | | | |
|--------|---------------|-----------|------------|
| F02.17 | Dynamic brake | Range:0~3 | Default: 0 |
|--------|---------------|-----------|------------|

When dynamic brake is enabled, the electric energy generated during Decel shall be converted into heat energy consumed by brake resistor, so as to attain rapid Decel. This brake method applies to brake of high-inertia load or the situations that require quick stop. In such a case, it is necessary to select appropriate dynamic brake resistor and break unit. The AC drives equal and below 30kW is provided with a standard built-in brake unit. Built-in brake unit is optional for AC drive 37kW~75kW.

- 0: Disabled
- 1: Enabled
- 2: Enabled at running
- 3: Enabled at deceleration

| | | | |
|--------|--------------------------|-----------------|---------------|
| F02.18 | Voltage of dynamic brake | Range:800~1200V | Default:1050V |
|--------|--------------------------|-----------------|---------------|

This parameter takes effect only to the drives with built-in brake unit.

When bus voltage of AC drive attains the value of F02.18, dynamic brake shall perform. The energy shall be rapidly consumed through brake resistor. This value is used to regulate the brake effect of brake unit.

| | | | |
|--------|-----------------|------------------|----------------|
| F02.19 | Brake use ratio | Range:5.0~100.0% | Default:100.0% |
|--------|-----------------|------------------|----------------|

It is valid only for the AC drive with internal braking unit and used to adjust the duty ratio of the braking unit. The larger the value of this parameter is, the better the braking result will be. However, too larger value causes great fluctuation of the AC drive bus voltage during the braking process.

| | | | |
|--------|----------------------|------------|------------|
| F02.20 | 0Hz Output selection | Range: 0~1 | Default: 0 |
|--------|----------------------|------------|------------|

- 0: No voltage output
- 1: Voltage output

| | | | |
|--------|--|------------------|---------------|
| F02.21 | Auto-start of power-on again | Range: 0~1 | Default: 0 |
| F02.22 | Waiting time between auto-start and power-on again | Range: 0.0~10.0s | Default: 0.5s |

Auto-start of power on again:

- 0:Invalid,after power off and power on again,inverter can't run before receiving running command.

When running on keyboard control or RS485 communication control,inverter will automatically clear running commands when power off.

When running on external terminal control , when power-off and then power on , no matter what value the function code F02.21 set, control commands of external terminal (FWD/REV) is valid . Inverter will run automatically according to starting mode that set before.

- 1: Valid

If inverter is in running condition before power-off, when power on again, after waiting time (set by F02.22), inverter will start automatically . The inverter will not accept run command within the waiting

time between power off and restart, but in the meantime if input stop command, inverter will clear restarting condition.

Attention: Power on again and auto-restart function can make inverter start running automatically after restoring the power. So, cause its big occasionality, please be careful to adopt this function for personal and equipment's safety.

Group F03 Accel/Decel Parameters

| | | | |
|--------|--------------|-------------------|---------------|
| F03.00 | Accel time 1 | Range:0.0~6000.0s | Default:15.0s |
| F03.01 | Decel time 1 | Range:0.0~6000.0s | Default:15.0s |
| F03.02 | Accel time 2 | Range:0.0~6000.0s | Default:15.0s |
| F03.03 | Decel time 2 | Range:0.0~6000.0s | Default:15.0s |
| F03.04 | Accel time 3 | Range:0.0~6000.0s | Default:15.0s |
| F03.05 | Decel time 3 | Range:0.0~6000.0s | Default:15.0s |
| F03.06 | Accel time 4 | Range:0.0~6000.0s | Default:15.0s |
| F03.07 | Decel time 4 | Range:0.0~6000.0s | Default:15.0s |

Accel time means required time for drive to Accelerate to maximum frequency F01.08 from zero frequency, while Decel time refers to the time required for drive to Decelerate to zero frequency from maximum frequency F01.08.

These four types of Accel/Decel time can be selected through the ON/OFF combination of DI terminals "Accel/Decel time determinant 1" and "Accel/Decel time determinant 2". See the following table.

| Accel/Decel time determinant 2 | Accel/Decel time determinant 1 | Accel/Decel time |
|--------------------------------|--------------------------------|--------------------------------------|
| OFF | OFF | Accel/Decel time 1 (F03.00、F03.01) |
| OFF | ON | Accel/Decel time 2 (F03.02、F03.03) |
| ON | OFF | Accel/Decel time 3 (F03.04、F03.05) |
| ON | ON | Accel/Decel time 4 (F03.06、F03.07) |

| | | | |
|--------|----------------|-------------------|---------------|
| F03.08 | Jog accel time | Range:0.0~6000.0s | Default:15.0s |
| F03.09 | Jog decel time | Range:0.0~6000.0s | Default:15.0s |

F03.08 and F03.09 set the rate of Accel/Decel of Jog, similar with F03.00~F03.07.

| | | | |
|--------|---|-------------------|--------------|
| F03.10 | Accel/Decel curve | Range:0~1 | Default: 0 |
| F03.11 | Initial segment time of acceleration of S curve | Range:0.0~6000.0s | Default:0.0s |
| F03.15 | End segment time of acceleration of S curve | Range:0.0~6000.0s | Default:0.0s |
| F03.16 | Initial segment time of deceleration of S curve | Range:0.0~6000.0s | Default:0.0s |
| F03.17 | End segment time of deceleration of S curve | Range:0.0~6000.0s | Default:0.0s |

0: Linear Accel/Decel

Accel/Decel is in linear mode.

1: S-curve Accel/Decel

The 1st section and the last section in accelerating or decelerating are in smooth transition. The acceleration/deceleration curve is similar to S curve. When it is in S curve, the final acceleration/deceleration time= S curve time+ Linear acceleration/deceleration time. See Figure 6-13 for 2 acceleration/deceleration modes.

See Figure 6-6 for 2 acceleration/deceleration modes.

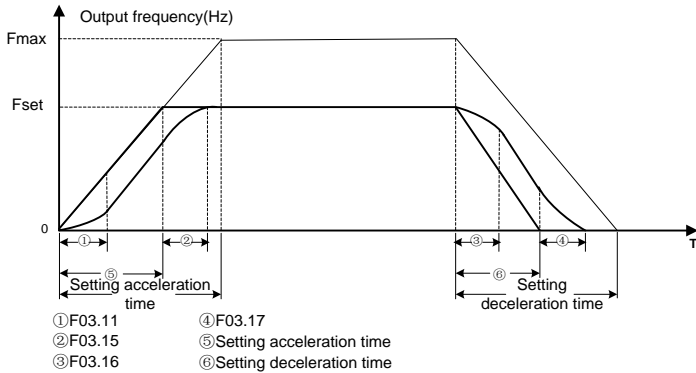

Figure 6-6

| | | | | |
|--------|--|----------|---|---|
| F03.12 | unit of acceleration and deceleration time | 0: 0.1s | 0 | × |
| | | 1: 0.01s | | |

This function is used to select unit of acceleration and deceleration time.

0: 0.1s

All the unit of acceleration and deceleration time is 0.1s, the function code decimal point of 4 section acceleration and deceleration time (F03.00~F03.07), jog acceleration and deceleration time, 4 section S-curve time (F03.11、F03.15~F03.17) is one.

1: 0.01s

All the unit of acceleration and deceleration time is 0.01s, the function code decimal point of 4 section acceleration and deceleration time (F03.00~F03.07), jog acceleration and deceleration time, 4 section S-curve time (F03.11、F03.15~F03.17) is two.

| | | | |
|--------|--|-----------------|----------------|
| F03.13 | Frequency switchover point between acceleration time 1 and acceleration time 2 | Range:0.00~Fmax | Default:0.00Hz |
| F03.14 | Frequency switchover point between deceleration time 1 and deceleration time 2 | Range:0.00~Fmax | Default:0.00Hz |

This function is valid when motor 1 is selected and acceleration/deceleration time switchover is not performed by means of DI terminal. It is used to select different groups of acceleration/deceleration time based on the running frequency range rather than DI terminal during the running process of the AC drive.

During acceleration, if the running frequency is smaller than the value of F03.13, acceleration time 2 is selected. If the running frequency is larger than the value of F03.13, acceleration time 1 is selected.

During deceleration, if the running frequency is larger than the value of F03.14, deceleration time 1 is selected. If the running frequency is smaller than the value of F03.14, deceleration time 2 is selected.

Figure 6-7 Acceleration/deceleration time switchovers.

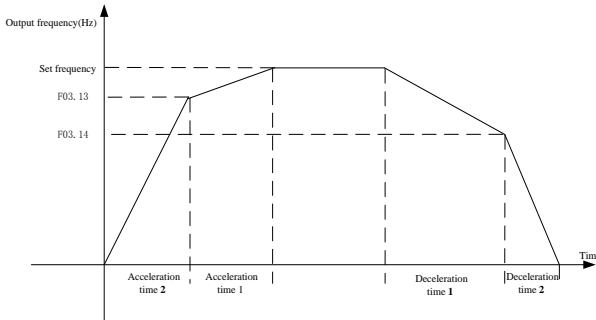

Figure 6-7

Group F04 Digital Input

| | | | | |
|--------|----------------------|-----|------------|------------|
| F04.00 | Function of terminal | DI1 | Range:0~99 | Default:1 |
| F04.01 | Function of terminal | DI2 | Range:0~99 | Default:2 |
| F04.02 | Function of terminal | DI3 | Range:0~99 | Default:7 |
| F04.03 | Function of terminal | DI4 | Range:0~99 | Default:13 |
| F04.04 | Function of terminal | DI5 | Range:0~99 | Default:0 |
| F04.05 | Function of terminal | DI6 | Range:0~99 | Default:0 |
| F04.06 | Function of terminal | DI7 | Range:0~99 | Default:0 |

| Value | Function | Description |
|-------|--|--|
| 0 | No function | Set 0 for reserved terminals to avoid malfunction. |
| 1 | Forward RUN (FWD) | Terminals control forward running and reverse running of the drive. Refer to F04.15 for enabled conditions on initial power up. |
| 2 | Reverse RUN (REV) | |
| 3 | Three-wire control | The terminal determines three-line control of the AC drive. For details, see the description of F04.15. |
| 4 | Forward JOG (FJOG) | FJOG indicates forward JOG running, while RJOG indicates reverse JOG running. The JOG frequency, acceleration time and deceleration time are described respectively in F01.07, F03.08 and F03.09. |
| 5 | Reverse JOG (RJOG) | |
| 6 | Coast to stop | The AC drive blocks its output, the motor coasts to rest and is not controlled by the AC drive. It is the same as coast to stop described in F02.12. |
| 7 | Fault reset (RESET) | The terminal is used for fault reset function, the same as the function of RESET key on the operation panel. Remote fault reset is implemented by this function. |
| 8 | RUN pause | The AC drive decelerates to stop, but the running parameters are all memorized, such as PLC, swing frequency and PID parameters. After this function is disabled, the AC drive resumes its status before stop. |
| 9 | Normally open (NO) input of external fault | If this terminal becomes ON, the AC drive reports Err13 and performs the fault protection action. For more details, see the description of F11.11. |
| 10 | Terminal UP | If the frequency is determined by external terminals, the Terminals with the two functions are used as increment and decrement commands for frequency modification. |
| 11 | Terminal DOWN | |

| | | |
|----|--|--|
| 12 | UP and DOWN setting clear (terminal, keypad) | If the frequency source is master frequency source setting, the terminal is used to clear the modification by using the UP/DOWN function or the increment/decrement key on the keypad, returning the set frequency to the value of master frequency source setting. |
| 13 | Multi-reference terminal 1 | The setting of 16 speeds or 16 other references can be implemented through combinations of 16 states of these four terminals. |
| 14 | Multi-reference terminal 2 | |
| 15 | Multi-reference terminal 3 | |
| 16 | Multi-reference terminal 4 | |
| 17 | Terminal 1 for acceleration/ deceleration time selection | Totally four groups of acceleration/deceleration time can be selected through combinations of two states of these two terminals. |
| 18 | Terminal 2 for acceleration/ deceleration time selection | |
| 19 | Acceleration/Deceleration prohibited | When "Accel/Decel disabled" terminal is enabled, the drive maintains the present output frequency and no longer responds to the change of command frequency. But it will still perform ramp-down stop when receiving stop command. This terminal is disabled during normal ramp-down stop. |
| 20 | Switch to auxiliary frequency source setting | Switch integrated frequency source setting mode to auxiliary frequency source setting mode. |
| 21 | PLC status reset | When simple PLC is running and this terminal is enabled. The status (running time and step) of PLC will be cleared and the output frequency is step 0. When this terminal is disabled again, the drive resumes PLC running from step 0. |
| 22 | Simple PLC paused | When simple PLC is running and this terminal is enabled, the current PLC status (running time and step) will be memorized, and the drive will run at 0Hz. When this terminal is disabled, the drive restores its running from the memorized moment. |
| 23 | PID pause | When this terminal is enabled, PID adjustment is paused, and the drive will maintain current output frequency. After this terminal becomes disabled, PID adjustment recovers. |
| 24 | Reverse PID action direction | After this terminal becomes ON, the PID action direction is reversed to the direction set in F13.04. |
| 25 | PID integral pause | After this terminal becomes ON, the integral adjustment function pauses. However, the proportional and differentiation adjustment functions are still valid. |
| 26 | PID parameter switchover | When PID parameter switch is set to "2: switched by terminal", this terminal could be used to realize the switching between two groups of PID parameters. When this terminal is enabled, PID parameters are Kp1 and Ti1, Td1. When this terminal is disabled, PID parameters are Kp2, Ti2 and Td2. |
| 27 | Swing frequency pause(output the current frequency) | The AC drive outputs the current frequency, and the swing frequency function pauses. |
| 28 | Swing frequency reset(output the central frequency) | The AC drive outputs the central frequency, and the swing frequency function pauses. |
| 29 | Run command | This terminal should be enabled by trigger edge. When this |

| | | |
|----|---|--|
| | switched to keypad control | terminal status is switched from OFF to ON, run command will be switched to keypad control. |
| 30 | Run command switched to terminal control | This terminal should be enabled by trigger edge. When this terminal status is switched from OFF to ON, run command will be switched to terminal control. |
| 31 | Run command switched to communication control | This terminal should be enabled by trigger edge. When this terminal is switched from OFF to ON, run command will be switched to communication control. |
| 32 | Count input | The maximum frequency at count pulse input terminal is 200Hz, and the count value can be memorized in case of power loss. With the setting of F14.07 (set count value) and 14.08 (designated count value), this terminal can control digital output "set count value attained" and "designated count value attained". |
| 33 | Count clear | Used with "count input" terminal, to clear pulse count value. |
| 34 | Length count | It is used for fixed-length control, and only takes effect on digital input terminal DI7/HL. The length is calculated via pulse input. Please refer to specification of parameters 14.04~F14.06 for details. When the length is attained, digital output terminal "length attained" shall output effective signal. The current length value will be memorized on power loss. |
| 35 | Length clear | Used with "length count" terminal, to clear the length calculated. |
| 36 | DC brake input command at stop | When inverter is in the process of ramp-to-stop, and running frequency < DC brake frequency (Set by F02.13) at stop, if the terminal is ON, DC brake starts, until the terminal is OFF, DC brake ends. If the terminal is ON, and DC brake setting time is effective, take the bigger value between time when terminal is ON and DC brake setting time at stop. |
| 37 | Speed/torque control switch | When motor control mode is sensor-less vector control 2 and inverter stop, inverter will switch from speed control mode to torque control mode if this function is valid |
| 38 | No reverse | If this function is valid, the motor can't reverse. |
| 39 | No forward | If this function is valid, the motor can't forward |

The four multi-reference terminals have 16 state combinations, corresponding to 16 reference values, as listed in the following table.

Table 1 State combination of the four multi-reference terminals

| Multi-reference terminal 4 | Multi-reference terminal 3 | Multi-reference terminal 2 | Multi-reference terminal 1 | Reference Setting | Corresponding Parameter |
|----------------------------|----------------------------|----------------------------|----------------------------|-------------------|-------------------------|
| OFF | OFF | OFF | OFF | Reference 0 | F12.16 |
| OFF | OFF | OFF | ON | Reference 1 | F12.01 |
| OFF | OFF | ON | OFF | Reference 2 | F12.02 |
| OFF | OFF | ON | ON | Reference 3 | F12.03 |
| OFF | ON | OFF | OFF | Reference 4 | F12.04 |
| OFF | ON | OFF | ON | Reference 5 | F12.05 |
| OFF | ON | ON | OFF | Reference 6 | F12.06 |

| | | | | | |
|-----|-----|-----|-----|--------------|--------|
| OFF | ON | ON | ON | Reference 7 | F12.07 |
| ON | OFF | OFF | OFF | Reference 8 | F12.08 |
| ON | OFF | OFF | ON | Reference 9 | F12.09 |
| ON | OFF | ON | OFF | Reference 10 | F12.10 |
| ON | OFF | ON | ON | Reference 11 | F12.11 |
| ON | ON | OFF | OFF | Reference 12 | F12.12 |
| ON | ON | OFF | ON | Reference 13 | F12.13 |
| ON | ON | ON | OFF | Reference 14 | F12.14 |
| ON | ON | ON | ON | Reference 15 | F12.15 |

Table 2 State combinations of two terminals for acceleration/deceleration time selection

| Acceleration/Deceleration time determinant 2 | Acceleration/Deceleration time determinant 1 | Acceleration/Deceleration Time Selection | Corresponding Parameters |
|--|--|--|--------------------------|
| OFF | OFF | Acceleration/Deceleration time 1 | F03.00、F03.01 |
| OFF | ON | Acceleration/Deceleration time 2 | F03.02、F03.03 |
| ON | OFF | Acceleration/Deceleration time 3 | F03.04、F03.05 |
| ON | ON | Acceleration/Deceleration time 4 | F03.06、F03.07 |

| | | | |
|--------|--|--------------------|----------------|
| F04.10 | Filtering time of digital input terminal | Range:0.000~1.000s | Default:0.010s |
|--------|--|--------------------|----------------|

Set the filtering time of DI1~DI7 (when DI7/HI is used as ordinary low-speed terminal), AI1, AI2 and AI3 (when used as digital input terminal). Interference immunity of digital input terminals can be improved by appropriate filtering time. However, the response time of digital input terminal will become slower when filtering time is increased.

ATTENTION:

This filtering time takes no effect on DI7/HI when DI7/HI terminal is used as DI high-speed input terminal, while the filtering time of DI is determined by parameter F06.36.

| | | | |
|--------|---|------------------|--------------|
| F04.11 | Delay time before terminal DI1 is valid | Range:0.0~300.0s | Default:0.0s |
| F04.12 | Delay time before terminal DI2 is valid | Range:0.0~300.0s | Default:0.0s |
| F04.19 | Delay time before terminal DI1 is invalid | Range:0.0~300.0s | Default:0.0s |
| F04.20 | Delay time before terminal DI2 is invalid | Range:0.0~300.0s | Default:0.0s |

The four parameters set the delayed response time before DI1/DI2 is valid or invalid

ATTENTION:

Terminal delay time F04.11 and F04.12 can be set with filtering time F04.10 at the same time. The drive will respond after the signals via DI1 and DI2 go through filtering time, and then delay time. Terminals DI3~DI7 have no delay time function.

| | | | |
|--------|--|-------------------|---------------|
| F04.13 | Terminal DI1~DI5 positive/negative logic | Range:00000~11111 | Default:00000 |
|--------|--|-------------------|---------------|

These parameters are used to set the valid mode of DI terminals.

Unit's place: DI1

0: Positive logic

The DI terminal is valid when being connected with COM, and invalid when being disconnected from COM.

1: Negative Logic

The DI terminal is invalid when being connected with COM, and invalid when being disconnected from COM.

Ten's digit: DI2 (same as DI1)

Hundred's digit: DI3 (same as DI1)

Thousand's digit: DI4 (same as DI1)

Ten thousand's digit: DI5 (same as DI1)

| | | | |
|--------|---|-------------------|---------------|
| F04.14 | Terminal DI6~AI3 positive/negative logic | Range:00000~11111 | Default:00000 |
|--------|---|-------------------|---------------|

Unit's place: DI6

0: Positive logic

The DI terminal is valid when being connected with COM, and invalid when being disconnected from COM.

1: Negative Logic

The DI terminal is invalid when being connected with COM, and invalid when being disconnected from COM.

Ten's digit: DI7 (same as DI6)

Hundred's digit: AI1

0: Positive logic ;< 3V, valid; > 7V, invalid

1: Negative Logic ;< 3V, invalid; > 7V, valid

Thousand's digit: AI2 (same as AI1)

Ten thousand's digit: AI3

0: Positive logic ;< -6V, valid; > 4V, invalid

1: Negative Logic ;< -6V, invalid; > 4V, valid

| | | | |
|--------|-----------------------|-----------|------------|
| F04.15 | Terminal command mode | Range:0~4 | Default: 0 |
|--------|-----------------------|-----------|------------|

This parameter is used to set the mode in which the AC drive is controlled by external terminals.

The following uses DI1, DI2 and DI3 among DI1 to DI7 as an example, with allocating functions of DI1, DI2 and DI3 by setting F4-00 to F4-02.

0: Two-line mode 1

It is the most commonly used two-line mode, in which the forward/reverse rotation of the motor is decided by DI1 and DI2. The parameters are set as below:

| Function Code | Parameter Name | Value | Function Description |
|---------------|------------------------|-------|----------------------|
| F04.15 | Terminal command mode | 0 | Two-line 1 |
| F04.00 | DI1 function selection | 1 | Forward RUN (FWD) |
| F04.01 | DI2 function selection | 2 | Reverse RUN (REV) |

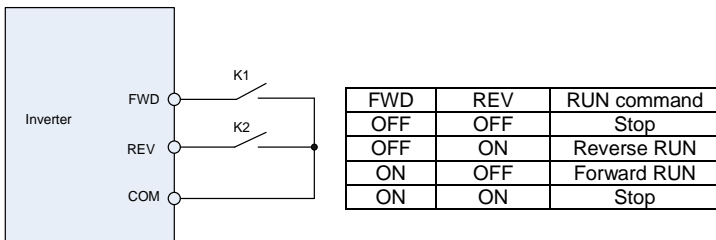

Figure 6-8 setting of two-line mode 1

As shown in the preceding figure, when only K1 is ON, the AC drive instructs forward rotation.

When only K2 is ON, the AC drive instructs reverse rotation. When K1 and K2 are ON & OFF simultaneously, the AC drives stops.

1: Two-line mode 2

In this mode, DI1 is RUN enabled terminal, and DI2 determines the running direction.

The parameters are set as below:

| Function Code | Parameter Name | Value | Function Description |
|---------------|------------------------|-------|----------------------|
| F04.15 | Terminal command mode | 1 | Two-line 2 |
| F04.00 | DI1 function selection | 1 | Forward RUN (FWD) |
| F04.01 | DI2 function selection | 2 | Reverse RUN (REV) |

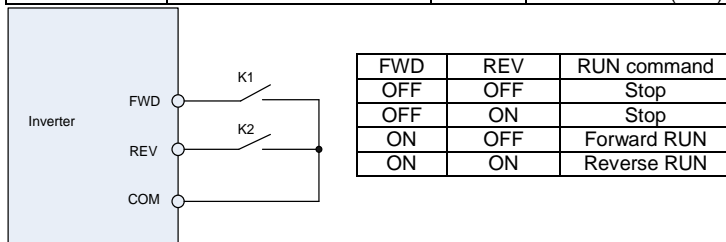

Figure 6-9 setting of two-line mode 2

As shown in the preceding figure, if K1 is ON, the AC drive instructs forward rotation when K2 is OFF, and instructs reverse rotation when K2 is ON. If K1 is OFF, the AC drives stops.

2: Three-line mode 1

In this mode, DI3 is RUN enabled terminal, and the direction is decided by DI1 and DI2.

The parameters are set as below:

| Function Code | Parameter Name | Value | Function Description |
|---------------|------------------------|-------|----------------------|
| F04.15 | Terminal command mode | 2 | Three-line 1 |
| F04.00 | DI1 function selection | 1 | Forward RUN (FWD) |
| F04.01 | DI2 function selection | 2 | Reverse RUN (REV) |
| F04.02 | DI3 function selection | 3 | Three-line control |

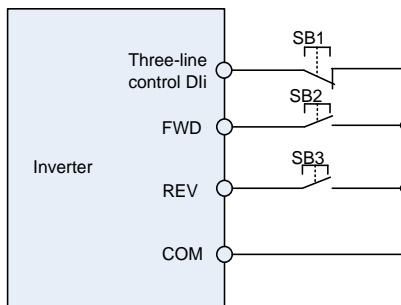

Figure 6-10 setting of three-line mode 1

As shown in the preceding figure, if SB1 is ON, the AC drive instructs forward rotation when SB2 is pressed to be ON and instructs reverse rotation when SB3 is pressed to be ON. The AC drives stops immediately after SB1 becomes OFF. During normal startup and running, SB1 must remain ON. The AC drive's running state is determined by the final actions on SB1, SB2 and SB3.

3: Three-line mode 2

In this mode, DI3 is RUN enabled terminal. The RUN command is given by DI1 and the direction is decided by DI2. The parameters are set as below:

| Function Code | Parameter Name | Value | Function Description |
|---------------|------------------------|-------|----------------------|
| F04.15 | Terminal command mode | 3 | Three-line 2 |
| F04.00 | DI1 function selection | 1 | Forward RUN (FWD) |
| F04.01 | DI2 function selection | 2 | Reverse RUN (REV) |
| F04.02 | DI3 function selection | 3 | Three-line control |

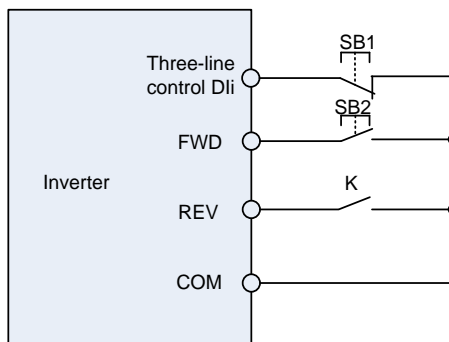

Figure 6-11 setting of three-line mode 2

As shown in the preceding figure, if SB1 is ON, the AC drive starts running when SB2 is pressed to be ON; the AC drive instructs forward rotation when K is OFF and instructs reverse rotation when K is ON. The AC drive stops immediately after SB1 becomes OFF. During normal startup and running, SB1 must remain ON. The AC drive's running state is determined by the final actions of SB1, SB2 and K.

4: Pulse operation stop

This model is using one touch control, to start and stop inverter by pulse, motor forward and reverse operation is determined by DI1 and DI2.

Function code setting:

| Function code | Name | Setting value | Function description |
|---------------|---|---------------|-------------------------|
| F04.15 | FWD/REV terminal control mode selection | 4 | Pulse operation stop |
| F04.00 | DI1 function selection | 1 | Forward operation (FWD) |
| F04.01 | DI2 function selection | 2 | Reverse operation (REV) |

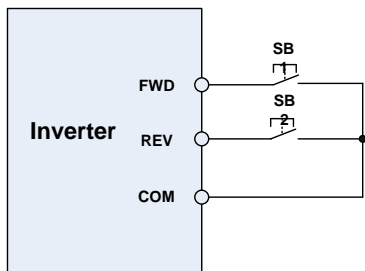

| | | |
|-------------------|-----|------|
| FWD | ↑ | ↑ |
| Operation command | FWD | Stop |
| REV | ↑ | ↑ |
| Operation command | REV | Stop |

Figure 6-12 Pulse operation stop control diagram

Press SB1, inverter forward operation, press SB1 again inverter stop; Press SB2, inverter reverse operation, press SB2 again, inverter stop.

Press the SB1 button inverter run clockwise, press the SB1 button to stop the SB2 button is pressed again converter; inverter reverse operation, press the SB2 button to stop again inverter.

| | | | |
|--------|---|------------------|--------------|
| F04.16 | Terminal UP/DOWN frequency adjustment treatment | Range:0000~11111 | Default:0000 |
|--------|---|------------------|--------------|

Unit's place: action when stop

0: Clear

Terminal UP/DOWN frequency adjustment value is cleared when the drive stops.

1: Holding

Terminal UP/DOWN frequency adjustment value is maintained when the drive stops.

Ten's place: action on power loss

0: Clear

Terminal UP/DOWN frequency adjustment value is cleared in case of power loss.

1: Holding

Terminal UP/DOWN frequency adjustment value is saved in case of power loss.

Hundred's digit: integral function

0: No integral function

Adjustment step size is kept constant during terminal UP/DOWN adjustment, in compliance with F04.17.

1: Integral function enabled

When frequency is adjusted through terminal UP/DOWN, initial step size is set by F04.17.

With the effective lasting time of the terminals, adjustment step size will increase gradually.

Thousand's place: UP/DOWN frequency adjust selection

0: Can't be reduced to negative frequency

When adjusted by terminal UP/DOWN, frequency can't be reduced to negative value

1: Can be reduced to negative frequency

When adjusted by terminal UP/DOWN, frequency can be reduced to negative value

Ten thousand's place: Jog function to clear UP/DOWN

0: Not clear

1: Clear

| | | | |
|--------|---|--------------------|----------------------|
| F04.17 | Terminal UP/DOWN frequency change step size | Range:0.00~50.00Hz | Default:1.00Hz/200ms |
|--------|---|--------------------|----------------------|

It is used to adjust the rate of change of frequency when the frequency is adjusted by means of terminal UP/DOWN.

| | | | |
|--------|--|------------|------------|
| F04.18 | Power on running terminal action selection | Range: 0~1 | Default: 0 |
|--------|--|------------|------------|

It is only valid to running command terminal which is set in number 1,2,4,5(Running forward, running reverse, JOG forward, JOG reverse), and only valid for the first running after power on.

0: Electrical level effective

When terminal is given running command, running terminal is detected to be ON, inverter start to run. Please ensure the terminal statue before power on.

1: Edge trigger + Electrical level effective(When power on)

When terminal is given running command, the terminal is detected to jump from OFF to ON and maintain ON, inverter start to run.

2: Edge trigger + Electrical level effective(Every start)

When terminal is given running command, the terminal is detected to jump from OFF to ON and maintain ON, inverter start to run.

Group F05 Digital Output

| | | | |
|--------|---|------------|------------|
| F05.00 | Y1 output function | Range:0~99 | Default:1 |
| F05.01 | Y2/HO output function (when used as Y2) | Range:0~99 | Default:3 |
| F05.02 | Relay 1 output function | Range:0~99 | Default:2 |
| F05.03 | Relay 2 output function | Range:0~99 | Default:11 |

Define the functions of digital output terminals Y1 & Y2, relay 1 and relay 2.Output terminal function selections are as follows:

| Setting | Corresponding function | Description |
|---------|---------------------------------------|---|
| 0 | No output | Output terminal is disabled, and there is no output. |
| 1 | Drive is running | The output is ON when the drive is running, and output is OFF when drive stopped. |
| 2 | Fault output | When the drive is in fault, outputs ON. |
| 3 | Frequency-level detection FDT1 output | Refer to the descriptions of F05.10 and F05.11. |
| 4 | Frequency-level detection FDT2 output | Refer to the descriptions of F05.12 and F05.13. |

| | | |
|----|--|---|
| 5 | Drive in 0Hz running 1(no output at stop) | When be running at 0Hz, this corresponding terminal outputs ON signal. No ON signal will be output at stop. |
| 6 | Drive in 0Hz running 2(output at stop) | Outputs ON signal when is running at 0Hz and also outputs ON signal at stop. |
| 7 | Upper limit frequency attained | When output frequency attains F01.09 (upper limit frequency), outputs ON. |
| 8 | Lower limit frequency attained (no output at stop) | When output frequency attains F01.10 (lower limit frequency), outputs ON. In the stop state, the terminal becomes OFF. |
| 9 | Frequency attained | Refer to the descriptions of F05.09. |
| 10 | Ready for RUN | If the AC drive main circuit and control circuit become stable, and the AC drive detects no fault and is ready for RUN, the terminal becomes ON. |
| 11 | Drive (motor) overloaded alarm | In case drive output current exceeds F11.19 (overload alarm threshold) and its last time exceeds F11.20 (overload alarm activated time that exceeding threshold), outputs ON. Refer to parameters F11.18~ F11.20 for information with regard to drive (motor) overloaded alarm. |
| 12 | Drive overheat alarm | When drive internally detected temperature exceeds F11.21 (Drive overheat alarm threshold), ON signal will be output. |
| 13 | Current running time attained | When current running time attains the value of F05.14, corresponding terminal outputs ON. Current running time is cleared when stop. |
| 14 | Accumulative power-on time attained | When accumulative power-on time attains the value of F05.15, corresponding terminal outputs ON. Accumulative power-on time is maintained when stop. |
| 15 | Accumulative running time attained | When accumulative running time attains the value of F05.16, corresponding terminal outputs ON. Accumulative running time is maintained when stop. |
| 16 | PLC cycle completed | Upon the completion of a cycle of simple PLC running, ON signal with a width of 250ms will be output. |
| 17 | Set count value attained | The terminal becomes ON when the count value reaches the value set in F14.07. |
| 18 | Designated count value attained | The terminal becomes ON when the count value reaches the value set in F14.08. Refer to the specification of parameter F14.07 and F14.08. |
| 19 | Length attained | The terminal becomes ON when the detected actual length exceeds the value set in F14.04. Refer to the specification of parameter F14.05~F14.07. |
| 20 | Under load alarm | When inverter under load, output ON signal |
| 21 | Brake Output | When the brake function selection is effective and reach brake open condition, output signal ON |
| 22 | DI1 | Output DI1 status |
| 23 | DI2 | Output DI2 status |
| 24 | Reach the range of FDT1 | When running frequency reach the range of FDT1's upper limit and lower limit, output signal ON |

| | | | |
|--------|---------------------------|-------------------|--------------|
| F05.04 | Y1 output delay time | Range:0.0~6000.0s | Default:0.0s |
| F05.05 | Y2 output delay time | Range:0.0~6000.0s | Default:0.0s |
| F05.06 | Relay 1 output delay time | Range:0.0~6000.0s | Default:0.0s |
| F05.07 | Relay 2 output delay time | Range:0.0~6000.0s | Default:0.0s |

These four parameters define the delay response time of digital output terminals Y1 & Y2, relay 1 and relay 2.

| | | | |
|--------|---------------------------------|-----------------|--------------|
| F05.08 | Enabled state of digital output | Range:0000~1111 | Default:0000 |
|--------|---------------------------------|-----------------|--------------|

Unit's place: Y1

- 0: Positive logic; ON when current passes through
 - 1: Negative logic; ON when no current passes through
 - Decade: Y2 (same as Y1)
 - Hundreds place: relay 1 output
 - 0: Positive logic; ON when there is coil excitation
 - 1: Negative logic; ON when there is no coil excitation
 - Thousands place: relay 2 output (same as relay 1)
- Wiring diagram of digital output terminal is shown as Fig. 6-12:

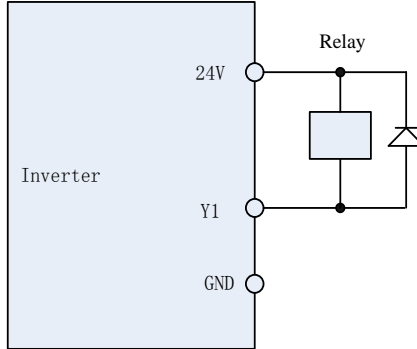

Fig. 6-12

| | | | |
|--------|---------------------------------------|------------------|---------------|
| F05.09 | Detection width of frequency attained | Range:0.0~20.0Hz | Default:5.0Hz |
|--------|---------------------------------------|------------------|---------------|

This parameter should be set with digital output terminal "frequency attained". When the difference between output frequency and command frequency is less than this value, terminal "frequency attained" outputs ON. See Fig. 6-13:

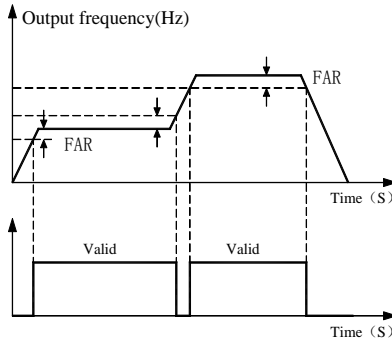

Fig. 6-13

| | | | |
|--------|------------------|-----------------|-----------------|
| F05.10 | FDT1 upper bound | Range:0.00~Fmax | Default:30.00Hz |
| F05.11 | FDT1 lower bound | Range:0.00~Fmax | Default:30.00Hz |
| F05.12 | FDT2 upper bound | Range:0.00~Fmax | Default:30.00Hz |
| F05.13 | FDT2 lower bound | Range:0.00~Fmax | Default:30.00Hz |

These parameters should be set with digital output terminals "FDT1" and "FDT2".

Take FDT1 for example, the drive outputs ON signal when output frequency exceeds upper bound of FDT1 and will not output OFF signal unless output frequency drops to below lower bound of FDT1. Please set F05.10 to be larger to some certain extent than F05.11, avoiding status change frequently. See Fig. 6-14:

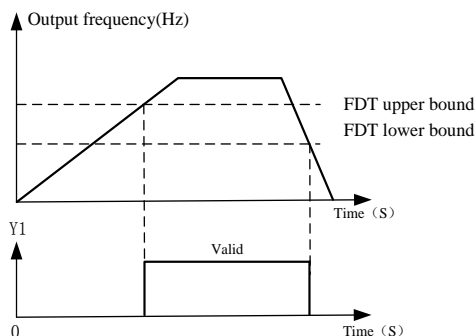

Fig. 6-14

| | | | |
|--------|--------------------------|---------------------|-----------------|
| F05.14 | Consecutive running time | Range:0.0~6000.0Min | Default: 0.0Min |
|--------|--------------------------|---------------------|-----------------|

This parameter should be set with digital output terminal "Consecutive running time attained". When current running time attains the value of F05.14, corresponding terminal outputs ON. Current running time is cleared when stop. When this parameter value is set to 0.0, this function is invalid.

| | | | |
|--------|----------------------------|----------------|-------------|
| F05.15 | Accumulative power-on time | Range:0~65535h | Default: 0h |
|--------|----------------------------|----------------|-------------|

This parameter should be set with digital output terminal "Accumulative power-on time attained". When accumulative power-on time attains the value of F05.15, corresponding terminal outputs ON. Accumulative power-on time is maintained when stop. When this parameter value is set to 0, this function is invalid.

| | | | |
|--------|---------------------------|----------------|-------------|
| F05.16 | Accumulative running time | Range:0~65535h | Default: 0h |
|--------|---------------------------|----------------|-------------|

This parameter should be set with digital output terminal "Accumulative running time attained". When accumulative running time attains the value of F05.16, corresponding terminal outputs ON. Accumulative running time is maintained when stop. When this parameter value is set to 0, this function is invalid.

| | | | |
|--------|-------------------------|------------|------------------|
| F05.17 | Brake control selection | Range: 0~1 | Default value: 0 |
|--------|-------------------------|------------|------------------|

0: Disabled

1: Enabled

| | | | |
|--------|----------------------------|---------------------|-----------------------|
| F05.18 | Brake open frequency | Range: 0.00~20.00Hz | Default value: 2.50Hz |
| F05.19 | Brake open current | Range: 0.0~200.0% | Default value: 0.0% |
| F05.20 | Brake open waiting time | Range: 0.00~10.00s | Default value: 0.00s |
| F05.21 | Brake open operating time | Range: 0.00~10.00s | Default value: 0.50s |
| F05.22 | Brake closed frequency | Range: 0.00~20.00Hz | Default value: 2.00Hz |
| F05.23 | Brake close waiting time | Range: 0.00~10.00s | Default value: 0.00s |
| F05.24 | Brake close operating time | Range: 0.00~10.00s | Default value: 0.50s |

Scheme of brake control process:

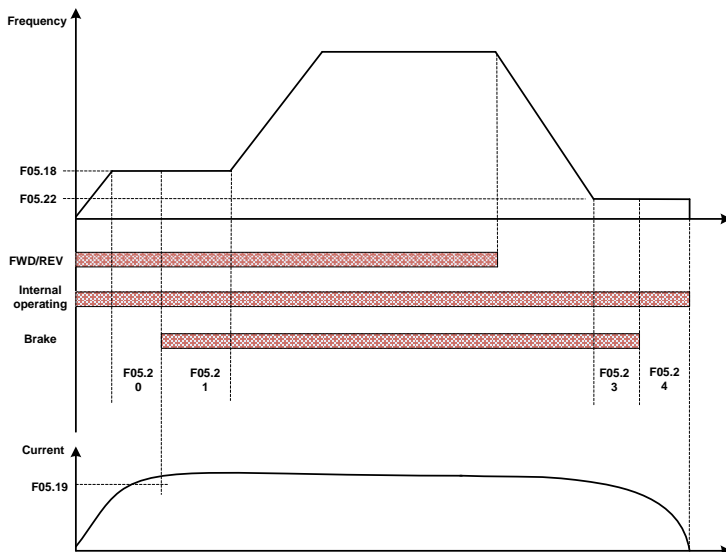

Fig 6-15 Break control logic scheme

- 1) After inverter receives a run command, accelerate the run to set F05.18 brake open frequency.
- 2) After the frequency reaches the F05.18 set frequency, inverter keeps constant running and the duration reaches the F05.20 set brake open waiting time, switching output "brake output" terminal output OFF signal.
- 3) After reaching the brake open waiting time, if inverter current is more than or equal with the F05.19 set brake open current, at this time switching output "brake output" terminal output signal ON, inverter continue working on the F05.18 set frequency, when operating time reaches the F05.21 set time, running starts acceleration up to set frequency.
- 4) After inverter receives the stop command, running decelerate to the F05.22 set brake closing frequency, and then operate on the constant frequency.
- 5) After running frequency reaches the F05.22 set frequency, after delay the F05.23 set brake closing delay time, this period of time, "Brake Output" output ON signal.
- 6) After reaching the F05.23 set time, "Brake Output" terminal output OFF signal, the inverter output frequency keeps the F05.22 set value, after delaying reach the F05.24 set value, inverter blocks output, get into stopped state.

Group F06 Analog and Pulse Input

| | | | |
|--------|---|---|-----------------|
| F06.00 | Minimum input of curve A11 | Range:0.0%~input of inflection point1 of curve A11 | Default:1.0% |
| F06.01 | Set value corresponding to minimum input of curve A11 | Range:-100.0~100.0% | Default:0.0% |
| F06.02 | Input of inflection point 1 of curve A11 | Range:Minimum input of curve A11~Input of inflection point 2 of curve A11 | Default:100.0% |
| F06.03 | Set value corresponding to input of inflection point 1 of curve A11 | Range:-100.0~100.0% | Default: 100.0% |
| F06.04 | Input of inflection point 2 of curve A11 | Range:Input of inflection point 1 of curve A11~Maximum input of curve A11 | Default: 100.0% |

| | | | |
|--------|---|---|-----------------|
| F06.05 | Set value corresponding to input of inflection point 2 of curve A11 | Range:-100.0~100.0% | Default: 100.0% |
| F06.06 | Maximum input of curve A11 | Range:Input of inflection point 2 of curve A11~100.0% | Default:100.0% |
| F06.07 | Set value corresponding to maximum input of curve A11 | Range:-100.0~100.0% | Default:100.0% |

Curve A11 is defined by above-noted 8 parameters.

Input values F06.00、F06.02、F06.04、F06.06:

A11~A12 are 0~10V or 0~20mA programmable by jumper on control board.

If 0~10V is selected: 0V corresponds to 0%, while 10V corresponds to 100%.

If 0~20mA is selected: 0mA corresponds to 0%, while 20mA corresponds to 100%.

AI3 only supports -10V~10V input; For AI3, -10V corresponds to -100%, while 10V corresponds to 100%.

Corresponding set values F06.01、F06.03、F06.05、F06.07:

When the corresponding set value is frequency: 100% is the maximum frequency, while -100% is the maximum negative frequency.

When corresponding set value is torque: 100% means 2 times the rated torque, while -100% Means negative "2 times the rated torque".

When the corresponding set value is output voltage (e.g. the voltage setting in case of V/f separated pattern): 100% corresponds to rated voltage of motor. "Less than or equal to 0%" corresponds to 0V voltage.

Curve diagram is shown as below:

For Instance:

Following description is taken A11 as the example.

(1) Parameter setting

Table 6-3(1) Parameter setting 1

| Code | Value | Code | Value |
|--------|-------|--------|--------|
| F06.01 | -100% | F06.00 | 0.0% |
| F06.03 | -50% | F06.02 | 25.0% |
| F06.05 | 70% | F06.04 | 75.0% |
| F06.07 | 100% | F06.06 | 100.0% |

Table 6-3(2) Parameter setting 2

| Code | Value | Code | Value |
|--------|-------|--------|-------|
| F06.01 | 100% | F06.00 | 0% |
| F06.03 | 70% | F06.02 | 40% |
| F06.05 | -50% | F06.04 | 75% |
| F06.07 | -100% | F06.06 | 100% |

See Figure 6-15 (1) and Figure 6-15 (2) for input/output bias of Table 6-3(1) and Table 6-3(2) respectively.

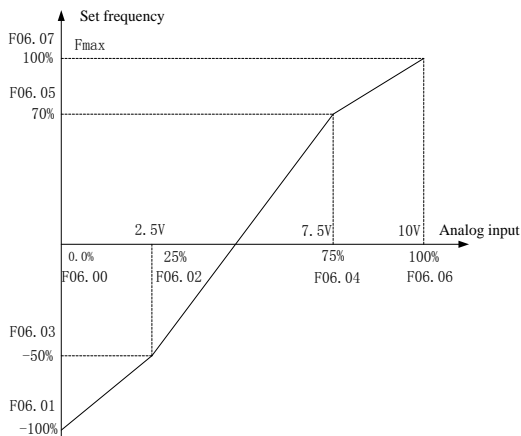

Figure 6-16 (1)

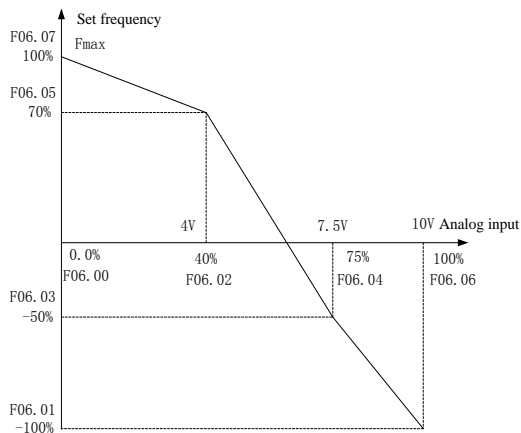

Figure 6-17 (2)

| | | | |
|--------|---|---|-----------------|
| F06.08 | Minimum input of curve AI2 | Range:0.0%~input of inflection point1 of curve AI2 | Default:1.0% |
| F06.09 | Set value corresponding to minimum input of curve AI2 | Range:-100.0~100.0% | Default:0.0% |
| F06.10 | Input of inflection point 1 of curve AI2 | Range:Minimum input of curve AI2~Input of inflection point 2 of curve AI2 | Default: 100.0% |
| F06.11 | Set value corresponding to input of inflection point 1 of curve AI2 | Range:-100.0~100.0% | Default: 100.0% |
| F06.12 | Input of inflection point 2 of curve AI2 | Range:Input of inflection point 1 of curve AI2~Maximum input of curve AI2 | Default: 100.0% |
| F06.13 | Set value corresponding to input of inflection point 2 of curve AI2 | Range:-100.0~100.0% | Default: 100.0% |
| F06.14 | Maximum input of curve | Range:Input of inflection | Default:100.0% |

| | | | |
|--------|---|---|-----------------|
| | A12 | point 2 of curve A12~100.0% | |
| F06.15 | Set value corresponding to maximum input of curve A12 | Range:-100.0~100.0% | Default:100.0% |
| F06.16 | Minimum input of curve A13 | Range:0.0%~input of inflection point1 of curve A13 | Default:0.0% |
| F06.17 | Set value corresponding to minimum input of curve A13 | Range:-100.0~100.0% | Default:-100.0% |
| F06.18 | Input of inflection point 1 of curve A13 | Range:Minimum input of curve A13~Input of inflection point 2 of curve A13 | Default:25.0% |
| F06.19 | Set value corresponding to input of inflection point 1 of curve A13 | Range:-100.0~100.0% | Default:-50.0% |
| F06.20 | Input of inflection point 2 of curve A13 | Range:Input of inflection point 1 of curve A13~Maximum input of curve A13 | Default:75.0% |
| F06.21 | Set value corresponding to input of inflection point 2 of curve A13 | Range:-100.0~100.0% | Default:25.0% |
| F06.22 | Maximum input of curve A13 | Range:Input of inflection point 2 of curve A13~100.0% | Default:100.0% |
| F06.23 | Set value corresponding to maximum input of curve A13 | Range:-100.0~100.0% | Default:100.0% |

Curve A12 is defined by F06.08~F06.15. Curve A13 is defined by F06.16~F06.23. The usage of curve A12 and curve A13 is the same as that of curve A11.

| | | | |
|--------|--|---|----------------|
| F06.24 | Minimum input of curve keypad potentiometer | Range:0.0~Maximum input of curve keypad potentiometer | Default:0.5% |
| F06.25 | Set value corresponding to minimum input of curve keypad potentiometer | Range:-100.0~100.0% | Default:0.0% |
| F06.26 | Maximum input of curve keypad potentiometer | Range: Minimum input of curve keypad potentiometer~100.0% | Default:99.9% |
| F06.27 | Set value corresponding to maximum input of curve keypad potentiometer | Range:-100.0~100.0% | Default:100.0% |

Curve keypad potentiometer is defined by above-noted 4 parameters.

Input values F06.24、F06.26:

keypad potentiometer is 0~5V on control board. 0V corresponds to 0%, while 5V corresponds to 100%.

Corresponding set values F06.25、F06.27:

When the corresponding set value is frequency: 100% is the maximum frequency, while -100% is the maximum negative frequency.

When corresponding set value is torque: 100% means 2 times the rated torque, while -100% means negative "2 times the rated torque".

When the corresponding set value is output voltage (e.g. the voltage setting in case of V/f separated pattern): 100% corresponds to rated voltage of motor. "Less than or equal to 0%" corresponds to 0V voltage. The difference is that curve keypad potentiometer is a straight line while curve A1~A13 is a broken line with two inflection points.

| | | | |
|--------|-------------------------------------|---------------------|----------------|
| F06.28 | A11 terminal filtering time | Range:0.000~10.000s | Default:0.100s |
| F06.29 | A12 terminal filtering time | Range:0.000~10.000s | Default:0.100s |
| F06.30 | A13 terminal filtering time | Range:0.000~10.000s | Default:0.100s |
| F06.31 | Keypad potentiometer filtering time | Range:0.000~10.000s | Default:0.100s |

F06.28~F06.31 define the filtering time of analog input terminals A11, A12, A13 and Keypad potentiometer. Long filtering time results in strong immunity from interference but slow response, while short filtering time brings rapid response but weak immunity from interference.

| | | | |
|--------|--|--|------------------|
| F06.32 | Minimum input of curve HI | Range:0.00kHz~Maximum input of curve HI | Default:0.00kHz |
| F06.33 | Set value corresponding to minimum input of curve HI | Range:-100.0~100.0% | Default:0.0% |
| F06.34 | Maximum input of curve HI | Range: Minimum input of curve HI~100.00kHz | Default:50.00kHz |
| F06.35 | Set value corresponding to maximum input of curve HI | Range:-100.0~100.0% | Default:100.0% |

Curve HI is defined by above-noted 4 parameters.

Input values F06.32、F06.34:

HI is 0~100kHz.

Corresponding set values F06.33、F06.35:

When the corresponding set value is frequency: 100% is the maximum frequency, while -100% is the maximum negative frequency.

When corresponding set value is torque: 100% means 2 times the rated torque, while -100% means negative "2 times the rated torque".

When the corresponding set value is output voltage (e.g. the voltage setting in case of V/f separated pattern): 100% corresponds to rated voltage of motor. "Less than or equal to 0%" corresponds to 0V voltage.

ATTENTION:

When pulse input is selected as the frequency command, DI7/HI terminal shall be set to "pulse input" function (F00.09 is set to 1).

| | | | |
|--------|----------------------------|---------------------|----------------|
| F06.36 | HI terminal filtering time | Range:0.000~10.000s | Default:0.100s |
|--------|----------------------------|---------------------|----------------|

F06.36 defines the filtering time of pulse input terminals DI7/HI. Long filtering time results in strong immunity from interference but slow response, while short filtering time brings rapid response but weak immunity from interference.

Group F07 Analog and Pulse Output

| | | | |
|--------|---------------------|------------|-----------|
| F07.00 | AO1 output function | Range:0~99 | Default:1 |
| F07.01 | AO2 output function | Range:0~99 | Default:2 |
| F07.02 | HO output function | Range:0~99 | Default:3 |

AO1 and AO2 are analog output terminals. Voltage output(0~10V) or current output(0~20mA) of AO1 and AO2 can be selected through toggle switch AO1 and AO2. When used as high-speed pulse output HO, Y2/HO terminal's functions are set in F00.11. Output range of HO pulse frequency is 0~F07.09 (maximum output pulse frequency).

The ranges of corresponding digital output of AO1, AO2 and HO are as shown in the following table.

| Value | Function | Range |
|-------|--------------------------|--|
| 0 | No output | No output |
| 1 | Output frequency | 0.00~Fmax |
| 2 | Command frequency | 0.00~Fmax |
| 3 | Output current | 0~2 times the rated current of inverter |
| 4 | Output voltage | 0~2 times the rated voltage of motor |
| 5 | Output power | 0~ 2 times the rated power |
| 6 | Bus voltage | 0~1000V |
| 7 | +10V | +10V |
| 8 | Keypad potentiometer | 0~5V |
| 9 | AI1 | 0~10V/0~20mA |
| 10 | AI2 | 0~10V/0~20mA |
| 11 | AI3 | -10~10V |
| 12 | HI | 0.01kHz~100.00kHz |
| 13 | Output torque | 0~2 times the rated torque |
| 14 | AO communication given 1 | Output values set by communication address 2005H |
| 15 | AO communication | Output values set by communication address 2006H |

| | | |
|--|---------|--|
| | given 2 | |
|--|---------|--|

| | | | |
|--------|------------|---------------------|---------------|
| F07.03 | AO1 offset | Range:-100.0~100.0% | Default:0.0% |
| F07.04 | AO1 gain | Range:-2.000~2.000 | Default:1.000 |

When users need to change AO1 measuring range or correct the error of meter, it can be realized by setting of F07.03 and F07.04. When using factory default set: 0~10V (or 0~20mA) of AO1 corresponds to "0~maximum". By expressing standard output of AO1 as x, the adjusted AO1 output as y, the gain as k, and the offset as b (100% of offset corresponds to 10V or 20mA), there is the equation:

$$y=kx+b$$

Example:

Set F07.00 to 1: output frequency. Standard AO1 output: AO1 outputs 0V when output frequency is 0, and outputs 10V when output frequency is maximum frequency. If AO1 is requested to output 2V when output frequency is 0.00Hz, and requested to output 8V when output frequency is the maximum frequency. There is: $2=k \cdot 0 + b$ and $8=k \cdot F_{max} + b$. From two equations, we obtain: $k=0.6$, $b=2V$, i.e. F07.03 is set to 20.0% while F07.04 is set to 0.600.

| | | | |
|--------|--------------------|---------------------|----------------|
| F07.05 | AO1 filtering time | Range:0.000~10.000s | Default:0.000s |
|--------|--------------------|---------------------|----------------|

Define output filtering time of AO1 terminal.

| | | | |
|--------|--------------------|---------------------|----------------|
| F07.06 | AO2 offset | Range:-100.0~100.0% | Default:0.0% |
| F07.07 | AO1 gain | Range:-2.000~2.000 | Default:1.000 |
| F07.08 | AO2 filtering time | Range:0.000~10.000s | Default:0.000s |

Adjustment method of AO2 output curve is the same as AO1.

| | | | |
|--------|-----------------------------------|----------------------|------------------|
| F07.09 | HO maximum output pulse frequency | Range:0.01~100.00kHz | Default:50.00kHz |
|--------|-----------------------------------|----------------------|------------------|

This parameter sets the maximum output frequency when Y2/HO terminal is selected as high-speed pulse output.

| | | | |
|--------|--------------------------|---------------------|----------------|
| F07.10 | HO output filtering time | Range:0.000~10.000s | Default:0.010s |
|--------|--------------------------|---------------------|----------------|

Set the filtering time of HO high-speed pulse output. Filtering can change the change rate of output pulse frequency. The longer the filtering time is, the lower the change rate of output pulse frequency would be.

Group F08 Parameters of Motor 1

| | | | |
|--------|------------------------|------------|------------|
| F08.00 | Motor 1 type selection | Range: 0~3 | Default: 0 |
|--------|------------------------|------------|------------|

0: Three phase asynchronous motors

1: Reverse

2: Single phase asynchronous motors(remove capacitance)

3: Single phase asynchronous motors(No need to remove capacitance)

| | | | |
|--------|----------------------------|--------------------|------------------------|
| F08.01 | Power rating of motor 1 | Range:0.1~1000.0kW | Default: Model defined |
| F08.02 | Rated voltage of motor 1 | Range:60~660V | Default: Model defined |
| F08.03 | Rated current of motor 1 | Range:0.1~1500.0A | Default: Model defined |
| F08.04 | Rated frequency of motor 1 | Range:20.00~Fmax | Default: Model defined |
| F08.05 | Rated speed of motor 1 | Range:1~60000rpm | Default: Model defined |

Set the parameters according to the motor nameplate no matter whether V/F control or vector control is adopted.

To achieve better V/F or vector control performance, motor auto-tuning is required. The motor auto-tuning accuracy depends on the correct setting of motor nameplate parameters.

| | | | |
|--------|--|----------------------|------------------------|
| F08.08 | Stator resistance R1 of async motor 1 | Range:0.001~65.535Ω | Default: Model defined |
| F08.09 | Rotor resistance R2 of async motor 1 | Range:0.001~65.535Ω | Default: Model defined |
| F08.10 | Leakage inductance L1 of async motor 1 | Range:0.001~65.535mH | Default: Model defined |
| F08.11 | Mutual inductance L2 of asynchronous motor 1 | Range:0.1~6553.5mH | Default: Model defined |
| F08.12 | No-load current of async | Range:0.1~1500.0A | Default: Model defined |

| | | | |
|--------|--|------------------|-------------------|
| | motor 1 | | |
| F08.13 | Field weakening coeff 1 of async motor 1 | Range:0.0~100.0% | Default:87% (1.1) |
| F08.14 | Field weakening coeff 2 of async motor 1 | Range:0.0~100.0% | Default:75% (1.6) |
| F08.15 | Field weakening coeff 2 of async motor 1 | Range:0.0~100.0% | Default:70% (3) |

The parameters in F08.08 to F08.15 are asynchronous motor parameters. These parameters are unavailable on the motor nameplate and are obtained by means of motor auto-tuning. Only F08.08 to F08.10 can be obtained through static motor auto-tuning. Through complete motor auto-tuning, encoder phase sequence and current loop PI can be obtained besides the parameters in F08.08 to F08.12. Each time "Rated motor power" (F08.01) or "Rated motor voltage" (F08.02) is changed, the AC drive automatically restores values of F08.08 to F08.12 to the parameter setting for the common standard Y series asynchronous motor.

If it is impossible to perform motor auto-tuning onsite, manually input the values of these parameters according to data provided by the motor manufacturer.

| | | | |
|--------|---------------------|---------------|------------|
| F08.21 | Motor's pole number | Range: 0~1000 | Default: 4 |
|--------|---------------------|---------------|------------|

| | | | |
|--------|-----------------------|-----------|------------|
| F08.30 | Autotuning of motor 1 | Range:0~2 | Default: 0 |
|--------|-----------------------|-----------|------------|

0: No auto-tuning

Auto-tuning is prohibited.

1: Asynchronous motor static auto-tuning

It is applicable to scenarios where complete auto-tuning cannot be performed because the asynchronous motor cannot be disconnected from the load. Before performing static auto-tuning, properly set the motor type and motor nameplate parameters of F08.00 to F08.07 first. The AC drive will obtain parameters of F08.08 to F08.10 by static auto-tuning. Set this parameter to 1, and press RUN. Then, the AC drive starts static auto-tuning.

2: Asynchronous motor complete auto-tuning

To perform this type of auto-tuning, ensure that the motor is disconnected from the load. During the process of complete auto-tuning, the AC drive performs static auto-tuning first and then accelerates to 80% of the rated motor frequency within the acceleration time 4. The AC drive keeps running for a certain period and then decelerates to stop within deceleration time 4.

Before performing complete auto-tuning, properly set the motor type, motor nameplate parameters of F08.00 to F08.07.

The AC drive will obtain motor parameters of F08.08 to F08.12 by complete auto-tuning.

Set this parameter to 2, and press RUN. Then, the AC drive starts complete auto-tuning.

ATTENTION:

1) Please make sure the motor is in a stationary status before autotuning, or autotuning cannot be performed normally.

2) Keypad displays "TUNE", and RUN indicator is lighting during autotuning. RUN indicator turns off upon the completion of autotuning.

3) If autotuning failed, the fault code "Err17" shall be displayed.

Group F09 V/f Control Parameters of Motor 1

| | | | |
|--------|-------------------|------------|------------|
| F09.00 | V/f curve setting | Range:0~13 | Default: 0 |
|--------|-------------------|------------|------------|

Set the relation between output voltage and output frequency of the drive when motor 1 is under V/f control.

0: Linear V/f

Applies to general constant-torque load. When drive output frequency is 0, output voltage will be 0, while when output frequency is rated frequency of motor, the output voltage would be rated voltage of motor.

1: Broken line V/f (determined by F09.03~F09.10)

Applies to spin drier, centrifuge, industrial washing machine and to other special loads. When drive output frequency is 0, output voltage will be 0, while when output frequency is rated frequency of motor, the output voltage would be rated voltage of motor. What is different is this pattern can set 4 inflection points by F09.03~F09.10.

2: 1.2nd power

3: 1.4th power

- 4: 1.6th power
- 5: 1.8th power
- 6: 2.0th power

Parameter values 2~6 apply to torque-dropped loads such as fans and water pumps. See Fig. 6-16.

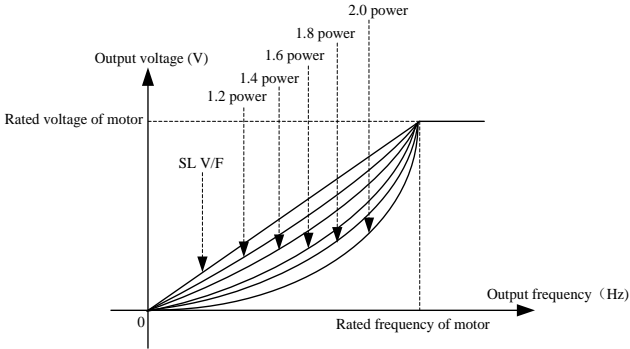

Fig. 6-24

7: V/F complete separation

In this mode, the output frequency and output voltage of the AC drive are independent. The output frequency is determined by the frequency source, and the output voltage is determined by "Voltage source for V/F separation" (F09.15). It is applicable to induction heating, inverse power supply and torque motor control.

8: V/F half separation

In this mode, V and F are proportional and the proportional relationship can be set in F09.15. The relationship between V and F are also related to the rated motor voltage and rated motor frequency in Group F08. Assume that the voltage source input is X (0 to 100%), the relationship between V and F is:

$$V/F = 2$$

$$\frac{V}{F} = \frac{V_{rated}}{F_{rated}} \times X$$

- 9: 1.2 power inverse curve
- 10: 1.4 power inverse curve
- 11: 1.6 power inverse curve
- 12: 1.8 power inverse curve
- 13: 2.0 power inverse curve

9~13 curve is for torque boost, which is rotated 180 degrees along diagonal line of 2~6 curve

| | | | |
|--------|-----------------------------------|-----------------|----------------|
| F09.01 | Torque boost | Range:0.0~30.0% | Default: 0.0% |
| F09.02 | Cut-off frequency of torque boost | Range:0.0~Fmax | Default:50.0Hz |

Torque boost:

Under V/f pattern, output voltage at low frequency can be compensated by this parameter, improving the torque output. 0.0% corresponds to automatic torque boost, and drive output voltage is automatically compensated via detection of load current. Automatic torque boost is valid only for linear V/f pattern. 100% of torque boost corresponds to rated voltage of motor. A non-zero value means the output voltage rises on the basis of V/f curve and this takes effect at parameter values 0~6 of F09.00. It is suggested this parameter value be gradually increased from zero until the starting requirement is met. Boost value is not suggested to be set to a relatively big one, as it is likely to bring about a bigger drive current and higher motor temperature.

Cut-off frequency of torque boost:

F09.02 specifies the frequency under which torque boost is valid. Torque boost becomes invalid when this frequency is exceeded, as shown in the following figure.

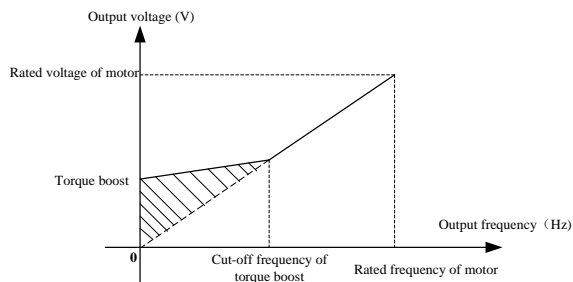

Fig. 6-25

| | | | |
|--------|---------------------------------|------------------------------------|----------------|
| F09.03 | Multi-point V/F frequency 1(F1) | Range:0.0~F09.05 | Default:0.0Hz |
| F09.04 | Multi-point V/F voltage 1(V1) | Range:0.0~100.0% | Default:0.0% |
| F09.05 | Multi-point V/F frequency 2(F2) | Range:F09.03~F09.07 | Default:5.0Hz |
| F09.06 | Multi-point V/F voltage 2(V2) | Range:0.0~100.0% | Default:14.0% |
| F09.07 | Multi-point V/F frequency 3(F3) | Range:F09.05~F09.09 | Default:25.0Hz |
| F09.08 | Multi-point V/F voltage 3(V3) | Range:0.0~100.0% | Default:50.0% |
| F09.09 | Multi-point V/F frequency 4(F4) | Range:F09.07~rated motor frequency | Default:50.0Hz |
| F09.10 | Multi-point V/F voltage 4(V4) | Range:0.0~100.0% | Default:100.0% |

F09.03~F09.10 is used for broken line V/f mode. Voltage value 100% corresponds to rated voltage of motor. Please rationally set the values of frequency and voltage at knees on the basis of characteristics of motor and load. Improper setting may rise output current even burn the motor. Figure 6-18 setting of multi-point V/F curve.

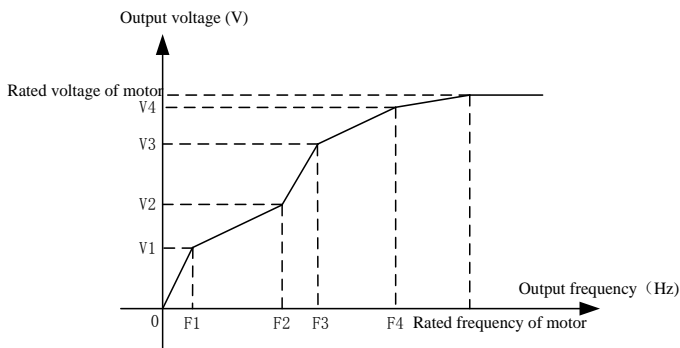

Fig. 6-26

ATTENTION:

The multi-point V/F curve is set based on the motor's load characteristic. The relationship between voltages and frequencies is: $V1 \leq V2 \leq V3 \leq V4$, $F1 \leq F2 \leq F3 \leq F4$. At low frequency, higher voltage may cause overheat or even burnt out of the motor and overcurrent stall or overcurrent protection of the AC drive.

| | | | |
|--------|----------------------------|------------------|----------------|
| F09.11 | V/F slip compensation gain | Range:0.0~300.0% | Default: 80.0% |
|--------|----------------------------|------------------|----------------|

This parameter is valid only for the asynchronous motor.

It can compensate the rotational speed slip of the asynchronous motor when the load of the motor increases, stabilizing the motor speed in case of load change.

| | | | |
|--------|--------------------------------------|------------------|----------------|
| F09.12 | Stator voltagedrop compensation gain | Range:0.0~200.0% | Default:100.0% |
|--------|--------------------------------------|------------------|----------------|

Stator voltage drop compensation is to compensate voltage drop produced by stator resistance and connecting cable.

| | | | |
|--------|-------------------------|------------------|------------------------|
| F09.13 | Excitation boost gain | Range:0.0~200.0% | Default:100.0% |
| F09.14 | Oscillation Suppression | Range:0.0~300.0% | Default: Model defined |

Set this parameter to a value as small as possible in the prerequisite of efficient oscillation suppression to avoid influence on V/F control. Set this parameter to 0 if the motor has no oscillation. Increase the value properly only when the motor has obvious oscillation. The larger the value is, the better the oscillation suppression result will be.

When the oscillation suppression function is enabled, the rated motor current and no-load current must be correct. Otherwise, the V/F oscillation suppression effect will not be satisfactory.

| | | | |
|--------|--|------------------|--------------|
| F09.15 | Voltage source for V/F separation | Range:0~7 | Default: 0 |
| F09.16 | Voltage digital setting for V/F separation | Range:0.0~100.0% | Default:0.0% |

V/F separation is generally applicable to scenarios such as induction heating, inverse power supply and motor torque control. If V/F separated control is enabled, the output voltage can be set in F09.15 or by means of analog, multi-reference, simple PLC, PID or communication. If you set the output voltage by means of non-digital setting, 100% of the setting corresponds to the rated motor voltage. If a negative percentage is set, its absolute value is used as the effective value.

- 0: Digital setting (F09.16)
- 1: Keypad potentiometer
- 2: AI1
- 3: Multi-reference
- 4: Pulse setting (DI7/HI)
- 5: PID
- 6: AI2
- 7: AI3

| | | | |
|--------|-------------------------------------|-------------------|--------------|
| F09.17 | Voltage rise time of V/F separation | Range:0.0~6000.0s | Default:0.1s |
|--------|-------------------------------------|-------------------|--------------|

This parameter value is the time rising from 0V to motor rated voltage or dropping from rated voltage to 0V.

Group F10 Vector Control Parameters of Motor 1

| | | | |
|--------|----------------------|-----------|------------|
| F10.00 | Speed/torque control | Range:0~1 | Default: 0 |
|--------|----------------------|-----------|------------|

Sensor-less vector control 2 and close-loop vector control support torque control. Under these two control patterns, speed control and torque control can be programmed by this parameter. Added to this, the switchover between speed control and torque control can also be realized by digital input terminal "speed/torque control switch". The relation of the switchover via terminal and parameter is shown in the following table:

| F10.00 | Speed/torque control switch terminal | Control mode |
|--------|--------------------------------------|----------------|
| 0 | OFF | Speed control |
| 0 | ON | Torque control |
| 1 | OFF | Torque control |
| 1 | ON | Speed control |

Under speed control, output torque of motor will match load automatically. In order to avoid overcurrent fault caused by excessive output torque, it is necessary to set appropriate torque limit value and keep output torque of motor within this limit. Please refer to the specification of F10.10 for torque limited information.

Under torque control, torque can be set by different sources, by F10.16. Under torque control, motor speed is determined by the difference between set torque and load torque. When the set torque is bigger than load torque, motor will be accelerated continuously. When the set torque is smaller than load torque, motor will be decelerated continuously. When the set torque is matching load torque well, the speed of motor will be maintained. Therefore, it is necessary to set limit value of forward or reverse speed during torque control so as to prevent over-run caused by continuous acceleration of motor. Please set the speed limits in F10.18~F10.19 under torque control.

ATTENTION:

Jog mode will run in the manner of speed control, and torque control is disabled.

| | | | |
|--------|--------------------------------------|---------------------|----------------|
| F10.01 | ASR low-speed proportional gain Kp1 | Range:0.0~100.0 | Default:15.0 |
| F10.02 | ASR low-speed integration time Ti1 | Range:0.001~30.000s | Default:0.050s |
| F10.03 | ASR switching frequency 1 | Range:0.0~F10.06 | Default:5.0Hz |
| F10.04 | ASR high-speed proportional gain Kp2 | Range:0.0~100.0 | Default:10.0 |
| F10.05 | ASR high-speed integration time Ti2 | Range:0.000~30.000s | Default:0.100s |
| F10.06 | ASR switching frequency 2 | Range:F10.03~Fup | Default:10.0Hz |

Speed loop PI parameters vary with running frequencies of the AC drive.

If the running frequency is less than or equal to "Switchover frequency 1" (F10.03), the speed loop PI parameters are F10.00 and F10.01.

If the running frequency is equal to or greater than "Switchover frequency 2" (F10.06), the speed loop PI parameters are F10.04 and F10.05.

If the running frequency is between F10.03 and F10.06, the speed loop PI parameters are obtained from the linear switchover between the two groups of PI parameters.

The speed dynamic response characteristics in vector control can be adjusted by setting the proportional gain and integral time of the speed regulator. To achieve a faster system response, increase the proportional gain and reduce the integral time. Be aware that this may lead to system oscillation.

The recommended adjustment method is as follows:

If the factory setting cannot meet the requirements, make proper adjustment. Increase the proportional gain first to ensure that the system does not oscillate, and then reduce the integral time to ensure that the system has quick response and small overshoot.

ATTENTION:

Improper PI parameter setting may cause too large speed overshoot, and overvoltage fault may even occur when the overshoot drops.

| | | | |
|--------|---------------------------|-------------------|---------------|
| F10.07 | ASR input filtering time | Range:0.0~500.0ms | Default:3.0ms |
| F10.08 | ASR output filtering time | Range:0.0~500.0ms | Default:0.0ms |

Sets the input/output filtering time of ASR. No need to modify its default setting if not have special requirement.

| | | | |
|--------|--------------------------|---------------|--------------|
| F10.09 | Vector control slip gain | Range:50~200% | Default:100% |
|--------|--------------------------|---------------|--------------|

For SFVC, it is used to adjust speed stability accuracy of the motor. When the motor with load runs at a very low speed, increase the value of this parameter; when the motor with load runs at a very large speed, decrease the value of this parameter.

For CLVC, it is used to adjust the output current of the AC drive with same load.

| | | | |
|--------|---|-------------------|--------------|
| F10.10 | Digital setting of torque upper limit in speed control mode | Range:50.0~200.0% | Default:165% |
|--------|---|-------------------|--------------|

In the speed control mode, the maximum output torque of the AC drive is restricted by F10.10.

| | | | |
|--------|---|--------------------|----------------|
| F10.11 | Excitation adjustment proportional gain Kp1 | Range:0.00~10.00 | Default:0.50 |
| F10.12 | Excitation adjustment integral gain Ti1 | Range:0.0~3000.0ms | Default:10.0ms |
| F10.13 | Torque adjustment proportional gain Kp2 | Range:0.00~10.00 | Default:0.50 |
| F10.14 | Torque adjustment integral gain Ti2 | Range:0.0~3000.0ms | Default:10.0ms |

These are current loop PI parameters for vector control. These parameters are automatically obtained through "Asynchronous motor complete auto-tuning" or "Synchronous motor no-load auto-tuning", and need not be modified.

| | | | |
|--------|-----------------------------|--------------------|-----------------|
| F10.15 | Excitation gain coefficient | Range: 50.0~200.0% | Default: 100.0% |
|--------|-----------------------------|--------------------|-----------------|

For sensorless vector control, the parameter is used to adjust the exciting current of the motor. When the motor torque is low, the parameter is increased, otherwise the parameter is decreased. For speed sensor vector control, this parameter can adjust the no-load excitation current of the motor.

| | | | |
|--------|--|-----------------|---------------|
| F10.16 | Torque setting source under torque control | Range:0~6 | Default:0 |
| F10.17 | Digital setting of torque | Range:-200~200% | Default:50.0% |

F10.16 is used to set the torque setting source. There are a total of 6 torque setting sources.

The torque setting is a relative value. 100.0% corresponds to the AC drives rated torque. The setting range is -200.0% to 200.0%, indicating the AC drive's maximum torque is twice of the AC drive's rated torque.

If the torque setting is positive, the AC drive rotates in forward direction. If the torque setting is negative, the AC drive rotates in reverse direction.

0: Digital setting (F10.17)

The target torque directly uses the value set in F10.17.

1: Keypad potentiometer

2: AI1

3: AI2

4: AI3

The target torque is decided by analog input.

5: Pulse setting (DI7/HI)

The target torque is set by DI7/HI (high-speed pulse). The pulse setting signal specification is 9–30 V (voltage range) and 0–100 kHz (frequency range). The pulse can only be input via DI7.

6: Communication setting

The target torque is set by means of communication.

| | | | |
|--------|--|----------------|----------------|
| F10.18 | Forward speed limited value under torque control | Range:0.0~Fmax | Default:50.0Hz |
| F10.19 | Reverse speed limited value under torque control | Range:0.0~Fmax | Default:50.0Hz |

When F00.26=0, Two parameters are used to set the maximum frequency in forward or reverse rotation in torque control mode.

In torque control, if the load torque is smaller than the motor output torque, the motor's rotational speed will rise continuously. To avoid runaway of the mechanical system, the motor maximum rotating speed must be limited in torque control.

You can implement continuous change of the maximum frequency in torque control dynamically by controlling the frequency upper limit.

| | | | |
|--------|-----------------------|-------------------|--------------|
| F10.20 | Set torque accel time | Range:0.0~6000.0s | Default:0.0s |
| F10.21 | Set torque decel time | Range:0.0~6000.0s | Default:0.0s |

In torque control, the difference between the motor output torque and the load torque determines the speed change rate of the motor and load. The motor rotational speed may change quickly and this will result in noise or too large mechanical stress. The setting of acceleration/deceleration time in torque control makes the motor rotational speed change softly.

However, in applications requiring rapid torque response, set the acceleration/deceleration time in torque control to 0.00s.

For example, two AC drives are connected to drive the same load. To balance the load allocation, set one AC drive as master in speed control and the other as slave in torque control. The slave receives the master's output torque as the torque command and must follow the master rapidly. In this case, the acceleration/deceleration time of the slave in torque control is set to 0.00s.

| | | | |
|--------|-------------------------------------|------------------|---------------|
| F10.22 | Static friction torque compensation | Range:0.0~100.0% | Default:5.0% |
| F10.23 | Static friction frequency range | Range:0.0~20.0Hz | Default:1.0Hz |

This parameter takes effect only in torque control. To compensate the static friction of system at the start, additional torque might be needed. When the motor runs, static friction torque compensation is disabled. 100% corresponds to rated torque of motor.

| | | | |
|--------|--------------------------------------|------------------|--------------|
| F10.24 | Sliding friction torque compensation | Range:0.0~100.0% | Default:1.0% |
|--------|--------------------------------------|------------------|--------------|

This parameter takes effect only in torque control. To compensate the sliding friction during running, additional torque might be needed. 100% corresponds to rated torque of motor.

| | | | |
|--------|-----------------------------|------------------|---------------|
| F10.25 | Rotary inertia compensation | Range:0.0~200.0% | Default:30.0% |
|--------|-----------------------------|------------------|---------------|

| | | | |
|--|-------|--|--|
| | coeff | | |
|--|-------|--|--|

This parameter takes effect only in torque control. This parameter value is to compensate mechanical rotary inertia during acceleration/deceleration.

| | | | | |
|-----------------------------|---|---------------------------|---|---|
| F10.26 | Max Frequency source under torque control | 0: Set by F10.18 & F10.19 | 0 | x |
| | | 1: Keypad potentiometer | | |
| | | 2: AI1 | | |
| | | 3: AI2 | | |
| | | 4: AI3 | | |
| 5: Pulse setting (DI7/HI) | | | | |

This parameter takes effect only in torque control. F10.26 is used to set the Max frequency source under torque control.

Group F11 Protection Parameters

| | | | |
|--------|---|--------------------|----------------|
| F11.00 | Current limit control | Range:0~2 | Default:2 |
| F11.01 | Current limit | Range:100.0~200.0% | Default:150.0% |
| F11.02 | Frequency decreasing time (limit current in constant speed operation) | Range:0.0~6000.0s | Default:5.0s |
| F11.03 | Current limit mode 2 proportion gain | Range:0.1~100.0% | Default:3.0% |
| F11.04 | Current limit mode 2 integral time | Range:0.00~10.00 | Default:10.00s |

F11.00=0: Current limit disabled

F11.00=1: Current limit mode 1

During acceleration and deceleration, if output current exceeds current limit (F11.01), inverter stops acceleration/deceleration and remains at present running frequency, and will accelerate/decelerate as per previous acceleration/deceleration time after output current decreased.

During steady state, after output current exceeds the current limit (F11.01), inverter decelerates as per the decreasing time (F11.02) of constant speed current frequency, and the minimum deceleration could reach lower limit frequency (F01.10). After output current decreases, inverter will accelerate to setting frequency as per setting acceleration time, see Figure 6-19.

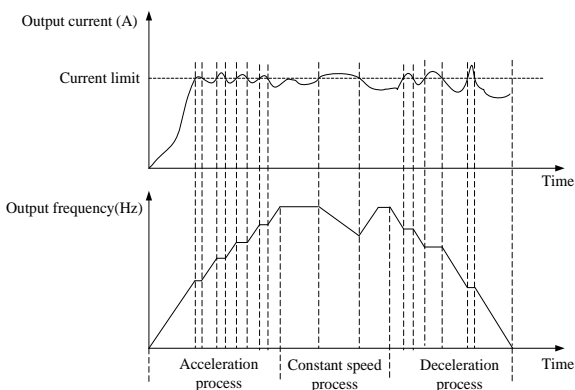

Figure 6-27

F11.00=2: Current limit mode 2

Current limit mode 2 is applied to the applications which are sensitive to acceleration/ deceleration time. In this mode, the motor current is automatically adjusted by regulating the output frequency as per the PI parameter set in F11.03 and F11.04.

For load with larger inertia if overcurrent occurs during acceleration, the proportional gain may be increased. For overcurrent during deceleration, the proportional gain may be decreased. For load with smaller inertia, the proportional gain may be kept smaller. Integral time can be adjusted for fine tuning in both cases.

| | | | |
|--------|---------------------------|-----------------|---------------|
| F11.05 | Overvoltage stall control | Range:0~2 | Default: 2 |
| F11.06 | Overvoltage stall voltage | Range:900~1200V | Default:1050V |

| | | | |
|--------|---|---------------------|-----------------|
| F11.07 | Overvoltage stall mode 2 proportion gain | Range:0.1~100.0% | Default:50.0% |
| F11.08 | Overvoltage stall mode2 frequency limited | Range: 0.00~50.00Hz | Default: 5.00Hz |

F11.05=0: Overvoltage Stall Disabled.

F11.05=1: Overvoltage Stall Mode 1

In deceleration process, after DC bus voltage exceeds overvoltage stall voltage (F11.06), inverter stops deceleration process, and remains at present running frequency. After DC bus voltage decreases, inverter will decelerate as per previous deceleration time, see Figure 6-20.

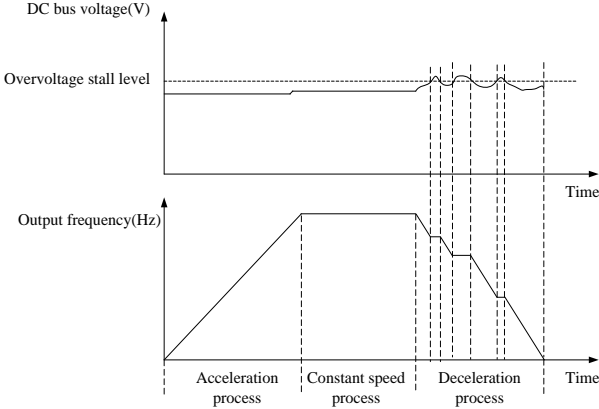

Figure 6-28

F11.05=2: Overvoltage Stall Mode 2

For large inertia load, mode 2 can be used when there are still overvoltage faults in mode 1. Mode 2 control bus voltage within the set values by adjusting output frequency. For larger inertia load, scaling factor(F11.07) of overvoltage stall mode 2 will be larger, otherwise, it will result in overvoltage fault when without good control. F11.08 function code control use to output frequency in mode 2.

| | | | |
|--------|---------------------|-------------------|---------------|
| F11.10 | Protection action 1 | Range:00000~33333 | Default:03330 |
|--------|---------------------|-------------------|---------------|

Unit's place: Bus undervoltage (Err07)

0: Fault reported and coast to stop

1: Stop according to the stop mode

2: Fault reported but continues to run

3: Fault protection disabled

Ten's digit: Power input phase Loss (Err09) (Same as unit's place)

Hundred's digit: Power output phase loss (Err10) (Same as unit's place)

Thousand's digit: Motor overload (Err11) (Same as unit's place)

Ten thousand's digit: Inverter overload (Err11) (Same as unit's place)

Note:

If "Coast to stop" is selected, the AC drive displays Err** and directly stops.

If "Stop according to the stop mode" is selected, the AC drive displays A** and stops according to the stop mode. After stop, the AC drive displays Err**.

If "Continue to run" is selected, the AC drive continues to run and displays A**. The running frequency is set in F11-14.

| | | | |
|--------|---------------------|-------------------|---------------|
| F11.11 | Protection action 2 | Range:00000~22222 | Default:00000 |
|--------|---------------------|-------------------|---------------|

Unit's place: External equipment fault (Err13)

0: Fault reported and coast to stop

1: Stop according to the stop mode

2: Fault reported but continues to run

Ten's digit: EEPROM read/write fault (Err15) (Same as unit's place)

Hundred's digit: Communication overtime error (Err18) (Same as unit's place)
 Thousand's digit: PID feedback loss (Err19) (Same as unit's place)
 Ten thousand's digit: Continuous running time reached (Err20) (Same as unit's place)

| | | | |
|--------|---------------------|--------------|-------------|
| F11.12 | Protection action 2 | Range: 00~32 | Default: 00 |
|--------|---------------------|--------------|-------------|

Unit's place: Module temperature detection disconnection (Err24)

- 0: Fault reported and coast to stop
- 1: Stop according to the stop mode
- 2: Fault reported but continues to run

Ten's digit: Load becoming 0 (Err25) (Same as unit's place)

| | | | |
|--------|--|----------------|----------------|
| F11.14 | Frequency selection for continuing to run upon fault | Range: 0~4 | Default: 00 |
| F11.15 | Backup frequency upon abnormality | Range:0.0~Fmax | Default: 0.0Hz |

- 0: Current running frequency
- 1: Set frequency
- 2: Frequency upper limit
- 3: Frequency lower limit

| | | | |
|--------|--------------------------------|-------------------|-------------|
| F11.17 | Motor overload protection time | Range:30.0~300.0s | Default:60s |
|--------|--------------------------------|-------------------|-------------|

4: Backup frequency upon abnormality (F11.15)

The default is that inverter trips Err11 fault if 150% overload lasts for 1 minute at hot start, see Figure 6-21 for motor overload protection time. During normal operation, motor overload protection operates in the area between a cold start and a hot start.

Cold start: Motor protection operation time in response to an overload situation that was suddenly reached when starting a stationary motor.

Hot start: Motor protection operation time in response to an overload situation that occurred during sustained operation at rated current.

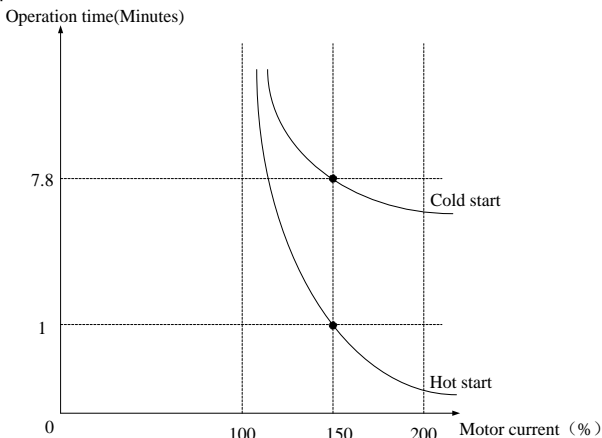

Figure 6-29

| | | | |
|--------|----------------|-------------------|---------------|
| F11.18 | Overload alarm | Range:00000~11111 | Default:00000 |
|--------|----------------|-------------------|---------------|

Unit's place: detection option

- 0: Always detect
Overload alarm works all the time during drive running.
- 1: Detect at constant speed only
Overload pre-alarm only works during constant-speed running of inverter.

Ten's place: compared object

- 0: Rated current of motor
Compared object is the rated current relative to motor, and display " A11" when the alarm is given under this setting
- 1: Rated current of drive

Compared object is the rated current of drive, and display " A12" when the alarm is given under this setting.

Hundred's place: Select whether report fault or not

0: Not report fault.

1: Report fault

Thousand's place: Select whether decelerate or not

0: Not decelerate

1: Decelerate

Ten thousand's place: Given mode for over-load level

0: F11.19 Set

1: F11.19 * VP(potentiometer on keypad)

2: F11.19 * AI1

3: F11.19 * AI2

4: F11.19 * AI3

| | | | |
|--------|--------------------------|-------------------|----------------|
| F11.19 | Overload alarm threshold | Range:20.0~200.0% | Default:130.0% |
|--------|--------------------------|-------------------|----------------|

When 0 is set at decade of F11.18, this set value is a percentage compared to rated current of motor. When 1 is set of that, this set value is a percentage compared to rated current of drive.

| | | | |
|--------|--|-----------------|--------------|
| F11.20 | Overload alarm activated time that exceeding threshold | Range:0.1~60.0s | Default:5.0s |
|--------|--|-----------------|--------------|

Set the lasting time that overload alarm is activated when output current of drive is bigger than the threshold set by F11.19.

| | | | |
|--------|-------------------------------------|---------------------------------|------------------------|
| F11.21 | Inverter overheat warning threshold | Range:50.0~overheat Temperature | Default: Model defined |
|--------|-------------------------------------|---------------------------------|------------------------|

Sets the threshold of drive t overheat alarm. When the maximum internal temperature of drive is higher than this value, the drive displays thermal alarm code "A14", but won't influence the running.

| | | | |
|--------|------------------------------|------------------|---------------|
| F11.22 | Detection level of load loss | Range:5.0~100.0% | Default:20.0% |
|--------|------------------------------|------------------|---------------|

| | | | |
|--------|-----------------------------|-----------------|--------------|
| F11.23 | Detection time of load loss | Range:0.1~60.0s | Default:5.0s |
|--------|-----------------------------|-----------------|--------------|

When the output current of the AC drive is lower than the detection level (F11.22) and the lasting time exceeds the detection time (F11.23), fault reported (Err25) and coast to stop.

| | | | |
|--------|---|------------|------------|
| F11.24 | Action selection at instantaneous power failure | Range: 0~2 | Default: 0 |
|--------|---|------------|------------|

0: Disabled

1: Deceleration

After power off, bus voltage is less than instantaneous power off bus voltage F11.30, and keep instantaneous power off voltage judge time F11.32, inverter start to reduce the running frequency via decel time at instantaneous power failure, the motor is in the state of power generation, the power feedback to maintain the bus voltage to ensure the normal running of inverter until the bus voltage is bigger than the instantaneous power off recovery voltage F11.31, then continue to run till the target frequency.

2: Bus voltage constant control

After power off, bus voltage is less than the instantaneous power off bus voltage F11.30, inverter will adjust the output frequency via PI adjustment F11.33 automatically

| | | | |
|--------|--|---|----------------|
| F11.25 | Decel time at instantaneous power failure | Range: 0.0~6000.0s | Default: 5.0s |
| F11.30 | Instantaneous power off bus voltage | Range: 60.0%~F11.31 | Default: 80.0% |
| F11.31 | Instantaneous power off recovery voltage | Range: F11.30~100.0% | Default: 85.0% |
| F11.32 | Instantaneous power off voltage judge time | Range: 0.01~10.00s | Default: 0.10s |
| F11.33 | Instantaneous power off gain Kp | Range: 0.1~100.0% | Default: 40.0% |
| F11.34 | Instantaneous integration time Ti | Range: 0.00~10.00s(0.00: Integration invalid) | Default: 0.10s |

Notice:

1. Proper adjustment of F11.25, can avoid production stop due to the protection of the inverter when power switch

2. Input phase lack protection function must be forbidden to enable this feature

| | | | |
|--------|---------------------|------------|------------|
| F11.26 | Rapid current limit | Range: 0~1 | Default: 0 |
|--------|---------------------|------------|------------|

0: Disabled

1: Enabled

The rapid current limit function can reduce the AC drive's overcurrent faults at maximum, guaranteeing uninterrupted running of the AC drive. However, long-time rapid current limit may cause the AC drive to overheat, which is not allowed. In this case, the AC drive will report Err26, indicating the AC drive is overloaded and needs to stop

| | | | |
|--------|--------------------------------------|------------|------------|
| F11.27 | Times of automatic trip(fault) reset | Range:0~20 | Default: 0 |
|--------|--------------------------------------|------------|------------|

It is used to set the times of fault auto resets if this function is used. After the value is exceeded, the AC drive will remain in the fault state.

| | | | |
|--------|---|------------------|--------------|
| F11.28 | Interval of automatic trip(fault) reset | Range:0.1~100.0s | Default:1.0s |
|--------|---|------------------|--------------|

It is used to set the waiting time from the alarm of the AC drive to fault auto reset.

| | | | |
|--------|-----------------------------------|-----------|------------|
| F11.29 | DO action during fault auto reset | Range:0~1 | Default: 0 |
|--------|-----------------------------------|-----------|------------|

0: Not act

1: Act

It is used to decide whether the DO acts during the fault auto reset if the fault auto reset function is selected.

| | | | |
|--------|--------------------------------------|------------|------------|
| F11.35 | The type of motor temperature sensor | Range: 0~2 | Default: 0 |
|--------|--------------------------------------|------------|------------|

0:None

1:PT100

2:PT1000

| | | | |
|--------|---|------------|------------|
| F11.36 | Select which port as the supply of the motor temperature sensor | Range: 0~2 | Default: 0 |
|--------|---|------------|------------|

0:None

1:AO1

Select AO1 as the power input of motor temperature sensor

2:AO2

Select AO2 as the power input of motor temperature sensor

| | | | |
|--------|---|------------|------------|
| F11.37 | Select which channel to detect the feedback voltage of motor temperature sensor | Range: 0~3 | Default: 0 |
|--------|---|------------|------------|

0:None

1:AI1

Select AI1 to detect the feedback voltage of motor temperature sensor

2:AI2

Select AI2 to detect the feedback voltage of motor temperature sensor .

3:AI3

Select AI3 to detect the feedback voltage of motor temperature sensor

| | | | |
|--------|--|-----------------|----------------|
| F11.38 | The threshold value of motor temperature warning | Range: 0~200 °C | Default: 90 °C |
|--------|--|-----------------|----------------|

| | | | |
|--------|---|-----------------|-----------------|
| F11.39 | The threshold value of motor temperature action | Range: 0~200 °C | Default: 110 °C |
|--------|---|-----------------|-----------------|

When the temperature detected by motor temperature sensor is greater than the value set by F11.38, inverter will give alarm and display A39 on keypad. When the temperature detected is greater than the value set by F11.39, inverter will report Err39.

Group F12 Multi-Reference and Simple PLC Function

| | | | |
|--------|--------------|---------------------|--------------|
| F12.00 | Reference 0 | Range:-100.0~100.0% | Default:0.0% |
| F12.01 | Reference 1 | Range:-100.0~100.0% | Default:0.0% |
| F12.02 | Reference 2 | Range:-100.0~100.0% | Default:0.0% |
| F12.03 | Reference 3 | Range:-100.0~100.0% | Default:0.0% |
| F12.04 | Reference 4 | Range:-100.0~100.0% | Default:0.0% |
| F12.05 | Reference 5 | Range:-100.0~100.0% | Default:0.0% |
| F12.06 | Reference 6 | Range:-100.0~100.0% | Default:0.0% |
| F12.07 | Reference 7 | Range:-100.0~100.0% | Default:0.0% |
| F12.08 | Reference 8 | Range:-100.0~100.0% | Default:0.0% |
| F12.09 | Reference 9 | Range:-100.0~100.0% | Default:0.0% |
| F12.10 | Reference 10 | Range:-100.0~100.0% | Default:0.0% |
| F12.11 | Reference 11 | Range:-100.0~100.0% | Default:0.0% |
| F12.12 | Reference 12 | Range:-100.0~100.0% | Default:0.0% |
| F12.13 | Reference 13 | Range:-100.0~100.0% | Default:0.0% |
| F12.14 | Reference 14 | Range:-100.0~100.0% | Default:0.0% |
| F12.15 | Reference 15 | Range:-100.0~100.0% | Default:0.0% |

At most 16 steps of multi-reference can be set by different status combinations of " multi-reference terminals 1~4" of digital input.

Multi-reference can be the setting source of frequency, V/F separated voltage and process PID. The multi-reference is relative value and ranges from -100.0% to 100.0%.

As frequency source, it is a percentage relative to the maximum frequency. As V/F separated voltage source, it is a percentage relative to the rated motor voltage. As process PID setting source, it does not require conversion.

Multi-reference can be switched over based on different states of DI terminals. For details, see the descriptions of group F4.

| | | | |
|--------|--------------------|-----------|------------|
| F12.16 | Reference 0 source | Range:0~6 | Default: 0 |
|--------|--------------------|-----------|------------|

- 0: Digital setting (F12.00)
- 1: keypad potentiometer
- 2: AI1
- 3: Process PID output
- 4: X7/HI pulse input
- 5: AI2
- 6: AI3

It determines the setting channel of reference 0. You can perform convenient switchover between the setting channels. When multi-reference or simple PLC is used as frequency source, the switchover between two frequency sources can be realized easily.

| | | | |
|--------|----------------------------|-----------------|--------------|
| F12.17 | Running mode of simple PLC | Range:0000~1132 | Default:0000 |
|--------|----------------------------|-----------------|--------------|

Unit's place: PLC running mode

0: Stop after a single cycle

PLC stops upon the completion of one cycle and it won't be started unless another run command is given, shown as Fig. 6-22.

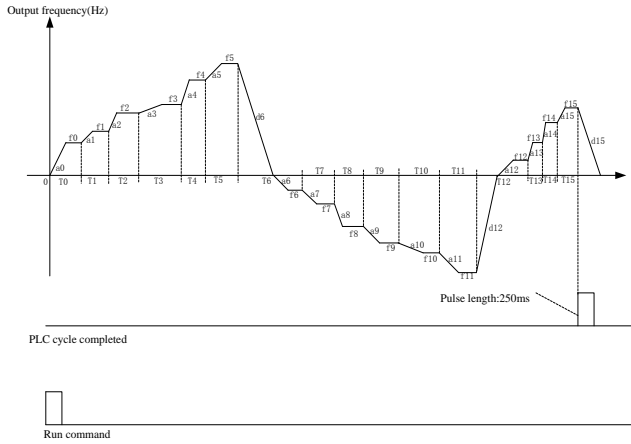

Fig. 6-30

1: Continue to run with the last frequency after a single cycle
 After the completion of one cycle, PLC maintains the running frequency and direction of the last step. See the figure below:

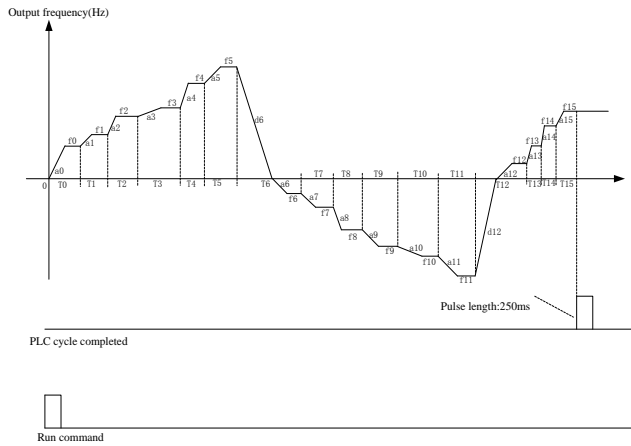

Fig. 6-31

2: Repeat cycles
 PLC automatically starts another cycle after finishing one until there is a stop command, shown as Fig. 6-24.

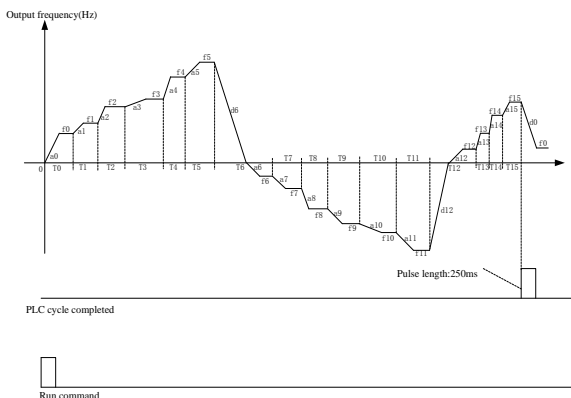

Fig. 6-32

Decade: started mode

0: Continue to run from the step of stop (or fault)

At the moment drive stop, the drive automatically records the running time of current step. When restarted, the drive will get into this step, continue to run the remanent time with the frequency of this step.

1: Run from the first step "multi-step reference 0"

When restarted after stop, the drive will start to run from "step 0".

2: Run from the Eighth step "multi-step reference 8"

When restarted after stop, the drive will start to run from "step 8".

3: Run from the Fifteenth step "multi-step reference 15"

When restarted after stop, the drive will start to run from "step15".

Hundreds place: power loss memory

0: Memory disabled on power loss

The drive does not memorize PLC running status on power loss and starts the running from step 0 after power up again.

1: Memory enabled on power loss

The drive saves PLC running status on power loss, including the running step, running frequency and finished running time at the moment of power loss. After the next power up, the running will be continued in accordance with the memorized status.

Thousands place: unit of simple PLC running time

0: Second

1: Hour

Set the unit of running time and Accel/Decel time of simple PLC.

| | | | |
|--------|-------------------------|----------------------|-----------------|
| F12.18 | Running time of step 0 | Range:0.0~6000.0s(h) | Default:0.0s(h) |
| F12.19 | Running time of step 1 | Range:0.0~6000.0s(h) | Default:0.0s(h) |
| F12.20 | Running time of step 2 | Range:0.0~6000.0s(h) | Default:0.0s(h) |
| F12.21 | Running time of step 3 | Range:0.0~6000.0s(h) | Default:0.0s(h) |
| F12.22 | Running time of step 4 | Range:0.0~6000.0s(h) | Default:0.0s(h) |
| F12.23 | Running time of step 5 | Range:0.0~6000.0s(h) | Default:0.0s(h) |
| F12.24 | Running time of step 6 | Range:0.0~6000.0s(h) | Default:0.0s(h) |
| F12.25 | Running time of step 7 | Range:0.0~6000.0s(h) | Default:0.0s(h) |
| F12.26 | Running time of step 8 | Range:0.0~6000.0s(h) | Default:0.0s(h) |
| F12.27 | Running time of step 9 | Range:0.0~6000.0s(h) | Default:0.0s(h) |
| F12.28 | Running time of step 10 | Range:0.0~6000.0s(h) | Default:0.0s(h) |
| F12.29 | Running time of step 11 | Range:0.0~6000.0s(h) | Default:0.0s(h) |
| F12.30 | Running time of step 12 | Range:0.0~6000.0s(h) | Default:0.0s(h) |
| F12.31 | Running time of step 13 | Range:0.0~6000.0s(h) | Default:0.0s(h) |
| F12.32 | Running time of step 14 | Range:0.0~6000.0s(h) | Default:0.0s(h) |

| | | | |
|--------|---|----------------------|-----------------|
| F12.33 | Running time of step 15 | Range:0.0~6000.0s(h) | Default:0.0s(h) |
| F12.34 | Acceleration/deceleration time of simple PLC reference 0 | Range: 0~3 | Default: 0 |
| F12.35 | Acceleration/deceleration time of simple PLC reference 1 | Range: 0~3 | Default: 0 |
| F12.36 | Acceleration/deceleration time of simple PLC reference 2 | Range: 0~3 | Default: 0 |
| F12.37 | Acceleration/deceleration time of simple PLC reference 3 | Range: 0~3 | Default: 0 |
| F12.38 | Acceleration/deceleration time of simple PLC reference 4 | Range: 0~3 | Default: 0 |
| F12.39 | Acceleration/deceleration time of simple PLC reference 5 | Range: 0~3 | Default: 0 |
| F12.40 | Acceleration/deceleration time of simple PLC reference 6 | Range: 0~3 | Default: 0 |
| F12.41 | Acceleration/deceleration time of simple PLC reference 7 | Range: 0~3 | Default: 0 |
| F12.42 | Acceleration/deceleration time of simple PLC reference 8 | Range: 0~3 | Default: 0 |
| F12.43 | Acceleration/deceleration time of simple PLC reference 9 | Range: 0~3 | Default: 0 |
| F12.44 | Acceleration/deceleration time of simple PLC reference 10 | Range: 0~3 | Default: 0 |
| F12.45 | Acceleration/deceleration time of simple PLC reference 11 | Range: 0~3 | Default: 0 |
| F12.46 | Acceleration/deceleration time of simple PLC reference 12 | Range: 0~3 | Default: 0 |
| F12.47 | Acceleration/deceleration time of simple PLC reference 13 | Range: 0~3 | Default: 0 |
| F12.48 | Acceleration/deceleration time of simple PLC reference 14 | Range: 0~3 | Default: 0 |
| F12.49 | Acceleration/deceleration time of simple PLC reference 15 | Range: 0~3 | Default: 0 |

Sets the running time for step 0~15 of simple PLC. The time unit is set by thousand's place of F12.17.

| | | | |
|--------|---|-----------------|---------------|
| F12.50 | UP/DOWN function selection of multi-reference | Range: 00~11 | Default: 00 |
| F12.51 | UP/DOWN speed of multi-reference | Range: 0.0~100% | Default: 0.0% |

Frequency of multi-reference can be adjusted by UP/DOWN function, adjustment speed is set by function code F12.51

Unit's place:Action selection when power off

0:Zero clearing when power off

1:keep the value when power off

Ten's place:select if it can be reduced to negative

0:Disable

1:Enable

Group F13 Process PID

The purpose of process PID control is to make feedback value consistent with the set value. PID control diagram is as shown in Fig. 6-25.

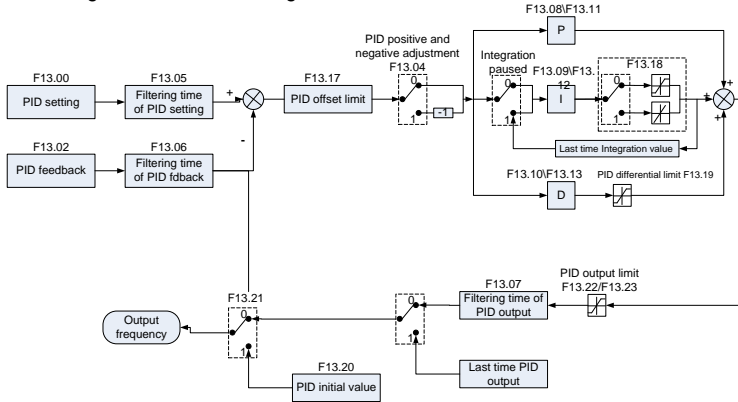

Fig. 6-33

| | | | |
|--------|-------------|------------|------------|
| F13.00 | PID setting | Range: 0~7 | Default: 0 |
|--------|-------------|------------|------------|

Select the setting source of PID control.

- 0: F13.01 digital setting
- 1: keypad potentiometer
- 2: AI1
- 3: Communication
- 4: Multi-Reference
- 5: DI7/HI pulse input
- 6: AI2
- 7: AI3

| | | | |
|--------|---------------------|------------------|---------------|
| F13.01 | PID digital setting | Range:0.0~100.0% | Default:50.0% |
|--------|---------------------|------------------|---------------|

When F13.00 is set to 0, this parameter value is taken as set value of PID.

| | | | |
|--------|--------------|-----------|-----------|
| F13.02 | PID feedback | Range:0~8 | Default:0 |
|--------|--------------|-----------|-----------|

Select the feedback source of PID control.

- 0: AI1
- 1: AI2
- 2: Communication
- 3: AI1+AI2
- 4: AI1-AI2
- 5: Max{AI1, AI2}
- 6: Min{AI1, AI2}
- 7: DI7/HI pulse input
- 8: AI3

| | | | |
|--------|----------------------------|------------------|---------------|
| F13.03 | PID setting feedback range | Range:0.0~6000.0 | Default:100.0 |
|--------|----------------------------|------------------|---------------|

This parameter is a non-dimensional unit. It is used for PID setting display (U00.11) and PID feedback display (U00.12).Relative value 100% of PID setting feedback corresponds to the value of F13.03.

If F13.03 is set to 1000 and PID setting is 50.0%, the PID setting display (U00.11) is 500.

| | | | |
|--------|----------------------|-----------|-----------|
| F13.04 | PID action direction | Range:0~1 | Default:0 |
|--------|----------------------|-----------|-----------|

- 0: Positive adjustment
- 1: Negative adjustment

This parameter can be used with digital input terminal "PID adjustment direction" to select positive or negative adjustment of PID.

| F13.04 | PID adjustment direction terminal | Adjustment |
|--------|-----------------------------------|------------|
| 0 | OFF | Positive |
| 0 | ON | Negative |

| | | |
|---|-----|----------|
| 1 | OFF | Negative |
| 1 | ON | Positive |

Positive adjustment:

When feedback signal is smaller than PID setting, output frequency of the drive will rise to reach PID balance.

When feedback signal is bigger than PID setting, output frequency of the drive will drop to reach PID balance.

Negative adjustment:

When feedback signal is smaller than PID setting, output frequency of the drive will drop to reach PID balance.

When feedback signal is bigger than PID setting, output frequency of the drive will rise to reach PID balance.

| | | | |
|--------|--------------------------------|---------------------|----------------|
| F13.05 | Filtering time of PID setting | Range:0.000~10.000s | Default:0.000s |
| F13.06 | Filtering time of PID feedback | Range:0.000~10.000s | Default:0.000s |
| F13.07 | Filtering time of PID output | Range:0.000~10.000s | Default:0.000s |

Set the filtering time of PID setting, feedback and output.

| | | | |
|--------|-----------------------|---------------------|----------------|
| F13.08 | Proportional gain Kp1 | Range:0.0~100.0 | Default:1.0 |
| F13.09 | Integration time Ti1 | Range:0.01~10.00s | Default:0.10s |
| F13.10 | Differential time Td1 | Range:0.000~10.000s | Default:0.000s |

Proportional gain Kp1:

It decides the regulating intensity of the PID regulator. The higher the Kp1 is, the larger the regulating intensity is. The value 100.0 indicates when the deviation between PID feedback and PID setting is 100.0%; the adjustment amplitude of the PID regulator on the output frequency reference is the maximum frequency.

Integral time Ti1:

It decides the integral regulating intensity. The shorter the integral time is, the larger the regulating intensity is. When the deviation between PID feedback and PID setting is 100.0%, the integral regulator performs continuous adjustment for the time set in FA-06. Then the adjustment amplitude reaches the maximum frequency.

Differential time Td1:

It decides the regulating intensity of the PID regulator on the deviation change. The longer the differential time is, the larger the regulating intensity is. Differential time is the time within which the feedback value change reaches 100.0%, and then the adjustment amplitude reaches the maximum frequency.

| | | | |
|--------|-----------------------|---------------------|----------------|
| F13.11 | Proportional gain Kp2 | Range:0.0~100.0 | Default:1.0 |
| F13.12 | Integration time Ti2 | Range:0.01~10.00s | Default:0.10s |
| F13.13 | Differential time Td2 | Range:0.000~10.000s | Default:0.000s |

In some applications, PID parameters switchover is required when one group of PID parameters cannot satisfy the requirement of the whole running process. These parameters are used for switchover between two groups of PID parameters. Regulator parameters F13.11 to F13.13 are set in the same way as F13.08 to F13.10.

| | | | |
|--------|--------------------------------------|------------------|---------------|
| F13.14 | PID parameter switch | Range:0~2 | Default: 0 |
| F13.15 | PID parameter switchover deviation 1 | Range:0.0~100.0% | Default:20.0% |
| F13.16 | PID parameter switchover deviation 2 | Range:0.0~100.0% | Default:80.0% |

Process PID is provided with two groups of proportional, integral and differential parameters, which is set by this parameter.

0: No switch, determined by parameters Kp1, Ti1 and Td1

Always determined by Kp1, Ti1 and Td1 set at F13.08 to F13.10.

1: Auto switched on the basis of input offset

When the offset between setting and feedback is less than the set value of F13.15, PID adjustment is determined by Kp1, Ti1 and Td1. When the offset between setting and feedback is bigger than the set value of F13.15, PID adjustment is determined by Kp2, Ti2 and Td2 set at F13.11 to F13.13.

2: Switched by terminal

When digital input terminal "PID parameters switch" is OFF, it is determined by Kp1, Ti1 and Td1. When "PID parameters switch" is ON, it is determined by Kp2, Ti2 and Td2

| | | | |
|--------|------------------|------------------|--------------|
| F13.17 | PID offset limit | Range:0.0~100.0% | Default:0.0% |
|--------|------------------|------------------|--------------|

If the offset between PID feedback and setting is more than this set value, PID regulator will implement regulation. If the offset between PID feedback and setting is less than this set value, PID will stop the regulation and the PID controller output will be kept unchanged. This function can improve the stability of PID performance.

| | | | |
|--------|-----------------------|-------------|------------|
| F13.18 | PID integral property | Range:00~11 | Default:00 |
|--------|-----------------------|-------------|------------|

Unit's digit (Whether to stop integral operation when the output reaches the limit)

0: Continue integral operation

1: Stop integral operation

If "Stop integral operation" is selected, the PID integral operation stops, which may help to reduce the PID, overshoot.

Ten's digit (Integral separated)

0: Invalid

1: Valid

If it is set to valid, the PID integral operation stops when the DI allocated with function 25 "PID integral pause" is ON In this case, only proportional and differential operations take effect.

If it is set to invalid, integral separated remains invalid no matter whether the DI allocated with function 25 "PID integral pause" is ON or not.

| | | | |
|--------|------------------------|------------------|--------------|
| F13.19 | PID differential limit | Range:0.0~100.0% | Default:0.5% |
|--------|------------------------|------------------|--------------|

Set differential output limit of PID control.

| | | | |
|--------|-------------------|------------------|--------------|
| F13.20 | PID initial value | Range:0.0~100.0% | Default:0.0% |
|--------|-------------------|------------------|--------------|

| | | | |
|--------|-----------------------------------|-------------------|--------------|
| F13.21 | Holding time of PID initial value | Range:0.0~6000.0s | Default:0.0s |
|--------|-----------------------------------|-------------------|--------------|

PID does not make adjustment when the drive starts its running, but outputs the value set by F13.20 and maintains the holding time set by F13.21, then starts PID adjustment. When F13.21 is set to 0.0, PID initial value is disabled. This function makes PID adjustment get into stable status fast.

| | | | |
|--------|----------------------------------|--|----------------|
| F13.22 | PID output frequency upper limit | Range: PID output frequency lower limit~100.0% | Default:100.0% |
|--------|----------------------------------|--|----------------|

| | | | |
|--------|----------------------------------|--|-----------------|
| F13.23 | PID output frequency lower limit | Range:-100.0%~PID output frequency upper limit | Default:-100.0% |
|--------|----------------------------------|--|-----------------|

This function is used to limit PID output frequency.100.0% corresponds to maximum frequency.

| | | | |
|--------|--------------------------------|-------------------|--------------|
| F13.24 | Low value of PID feedback loss | Range:0.0%~100.0% | Default:0.0% |
|--------|--------------------------------|-------------------|--------------|

| | | | |
|--------|---|-----------------|--------------|
| F13.25 | Detection time for low value of PID feedback loss | Range:0.0~30.0s | Default:1.0s |
|--------|---|-----------------|--------------|

| | | | |
|--------|---------------------------------|-------------------|----------------|
| F13.28 | High value of PID feedback loss | Range:0.0%~100.0% | Default:100.0% |
|--------|---------------------------------|-------------------|----------------|

| | | | |
|--------|--|-----------------|--------------|
| F13.29 | Detection time for high value of PID feedback loss | Range:0.0~30.0s | Default:1.0s |
|--------|--|-----------------|--------------|

When the PID feedback value is not in the range of F13.24 and F13.28, and lasting time attains the set of F13.25/F13.28, then inverter will report Err19(PID feedback loss).

| | | | |
|--------|-----------------------|-------------------|-------------|
| F13.26 | PID operation at stop | Range:00000~11111 | Default:000 |
|--------|-----------------------|-------------------|-------------|

Unit's place:operation selection when power off

0: No PID operation at stop

1: PID operation at stop

It is used to select whether to continue PID operation in the state of stop. Generally, the PID operation stops when the AC drives stops.

Ten's place: PID output is limited by output frequency

0: No limit

1: limit

When using PID regulation, Setting "1"can prevent output lags caused by the existence of acceleration and deceleration.

Hundred's place: Action selection when using UP/DOWN function to modify the frequency in PID mode.

0:Zero clearing when power off.

Clear the value (increased or decreased) caused by UP/DOWN function when power off
 1: Keep the value when power off.
 Keep the value (increased or decreased) caused by UP/DOWN function when power off
Thousand's place: Select whether to detect PID feedback loss or not at stop.
 0: No detection at stop.
 1: Do detection at stop
Ten thousand's place: Select action for PID feedback loss
 0: Report fault
 1: Ramp to stop

| | | | |
|--------|------------------------------------|--------------------------------|---------------|
| F13.27 | UP/DOWN speed of PID digital given | Range:0.0 ~ 100%(0.0% invalid) | Default: 0.0% |
|--------|------------------------------------|--------------------------------|---------------|

This function code is to set the speed of UP/DOWN function, value 100% corresponding to 50Hz.

Group F14 Swing Frequency, Fixed Length, Count and Wakeup

The swing frequency function is applied to the textile and chemical fiber fields and the applications where traversing and winding functions are required.

The swing frequency function indicates that the output frequency of the AC drive swings up and down with the set frequency as the center. The trace of running frequency at the time axis is shown in the following figure. The swing amplitude is set in F14.00 and F14.01. When F14.01 is set to 0, the swing amplitude is 0 and the swing frequency does not take effect.

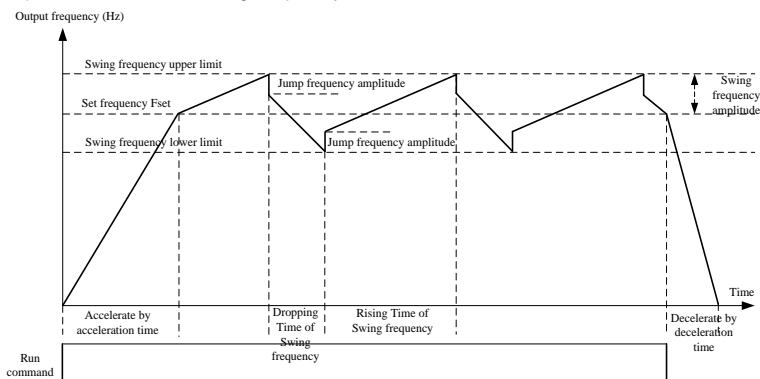

Figure 6-34

| | | | |
|--------|------------------------------|-----------|-----------|
| F14.00 | Swing frequency setting mode | Range:0~1 | Default:0 |
|--------|------------------------------|-----------|-----------|

This parameter is used to select the base value of the swing amplitude.

0: Relative to the central frequency (group F01)

It is variable swing amplitude system. The swing amplitude varies with the central frequency (set frequency).

1: Relative to the maximum frequency (F01.08 maximum output frequency)

It is fixed swing amplitude system. The swing amplitude is fixed.

| | | | |
|--------|---------------------------|------------------|--------------|
| F14.01 | Swing frequency amplitude | Range:0.0~100.0% | Default:0.0% |
| F14.02 | Jump frequency amplitude | Range:0.0~50.0% | Default:0.0% |

This parameter is used to determine the swing amplitude and jump frequency amplitude.

If relative to the central frequency (F14.00 = 0), the actual swing amplitude AW is the calculation result of group F01 (Frequency source selection) multiplied by F14.01.

If relative to the maximum frequency (F14.00 = 1), the actual swing amplitude AW is the calculation result of F01.08 (Maximum frequency) multiplied by F14.01.

Jump frequency = Swing amplitude AW x F14.02 (Jump frequency amplitude). If relative to the central frequency (F14.00 = 0), the jump frequency is a variable value. If relative to the maximum frequency (F14.00 = 1), the jump frequency is a fixed value.

The swing frequency is limited by the frequency upper limit and frequency lower limit.

| | | | |
|--------|----------------------------------|-------------------|--------------|
| F14.03 | Rising Time of Swing frequency | Range:0.0~6000.0s | Default:5.0s |
| F14.04 | Dropping Time of Swing frequency | Range:0.0~6000.0s | Default:5.0s |

See Figure 6-26.

| | | | |
|--------|----------------------------|------------------|---------------|
| F14.05 | Set length | Range:0~65535m | Default:1000m |
| F14.06 | Number of pulses per meter | Range:0.0~6553.5 | Default:100.0 |

The preceding parameters are used for fixed length control.

The length information is collected by DI terminals. U00.27 (Actual length) is calculated by dividing the number of pulses collected by the DI terminal by F14.06 (Number of pulses each meter). When the actual length U00.27 exceeds the set length in F14.05, the DO terminal allocated with function (Length reached) becomes ON. During the fixed length control, the length reset operation can be performed via the DI terminal allocated with function 35. For details, see the descriptions of F04.00 to F04.09.

Allocate corresponding DI terminal with function 34 (Length count input) in applications. If the pulse frequency is high, DI7/HI must be used.

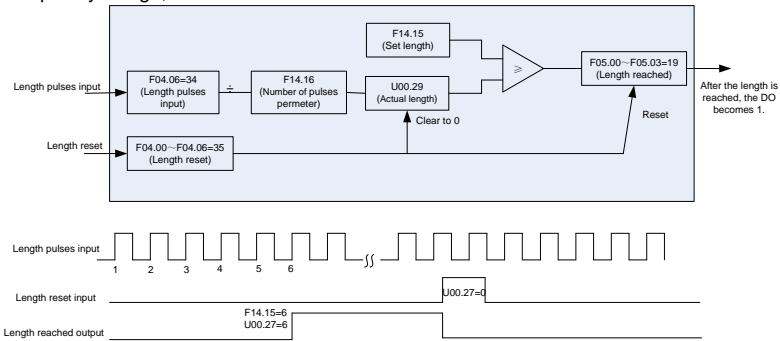

Figure 6-35

| | | | |
|--------|----------------------------------|-----------|------------|
| F14.07 | Command when the length attained | Range:0~1 | Default: 0 |
|--------|----------------------------------|-----------|------------|

- 0: Not stop
- 1: Stop

This parameter sets the action of the drive when actual length attains the length set by F14.05. Actual length can be cleared through digital input terminal "length clear".

ATTENTION:

- When actual length is detected to attain the set length, digital output terminal "length attained" outputs ON signal no matter the drive is set to stop or not stop.
- Actual length is saved at power loss and can be read in both stop and running.

| | | | |
|--------|------------------------|---------------|--------------|
| F14.08 | Set count value | Range:1~65535 | Default:1000 |
| F14.09 | Designated count value | Range:1~65535 | Default:1000 |

The count value needs to be collected by DI terminal. Allocate the corresponding DI terminal with function 32 (Counter input) in applications. If the pulse frequency is high, DI7/HI must be used.

When the count value reaches the set count value (F14.08), the DO terminal allocated with function 17 (Set count value reached) becomes ON. Then the counter stops counting.

When the counting value reaches the designated counting value (F14.09), the DO terminal allocated with function 17 (Designated count value reached) becomes ON. Then the counter continues to count until the set count value is reached.

F14.09 should be equal to or smaller than F14.08.

Figure 6-28 Reaching the set count value and designated count value

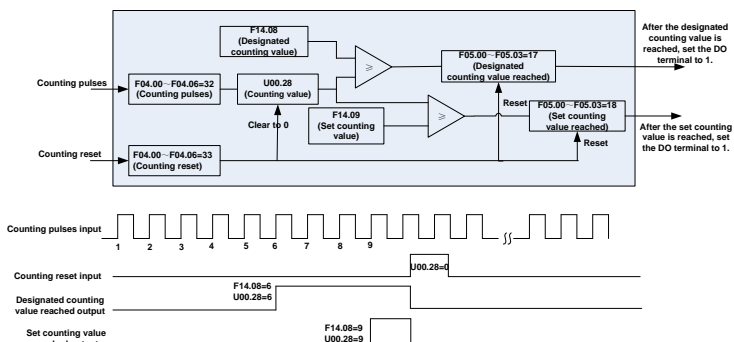

Figure 6-36

ATTENTION:

Actual count value can be cleared through digital input terminal "count clear".
Actual count value is saved at power loss.

| | | | |
|--------|---------------------|--------------------------------|-----------------|
| F14.10 | Wake up frequency | Range:Dormancy frequency~Fmax | Default: 0.00Hz |
| F14.11 | Wake up delay time | Range: 0.0~6000.0s | Default: 0.0s |
| F14.12 | Dormancy frequency | Range: 0.00~Wake up frequency | Default: 0.00Hz |
| F14.13 | Dormancy delay time | Range: 0.0~6000.0s | Default: 0.0s |
| F14.17 | Wake up pressure | Range: 0.0%~Dormancy pressure | Default: 10.0% |
| F14.18 | Dormancy pressure | Range: Wake up pressure~100.0% | Default: 50.0% |

The parameters are used for the dormancy and wake up function in water supply application. During inverter operation, when F14.15 set to be "0", and when setting frequency is lower than F14.12, after delay time of F14.13, inverter entry dormancy and stop. When F14.15 set to be "1", and when pressure feedback is bigger than F14.18, after delay time of F14.13, inverter entry dormancy and stop.

During inverter dormancy, when F14.14 set to be "0", and when setting frequency is bigger than F14.12, after delay time of F14.11, inverter start to operate; When F14.14 set to be "1", and when pressure feedback is lower than F14.17, after delay time of F14.11, inverter start to operate.

Usually, please set wake up frequency bigger than dormancy frequency. If wake up frequency and dormancy frequency are set to be 0.00Hz, wake up and dormancy function is invalid.

When start dormancy function, if frequency source is PID, need to set F13.26 to be "1" PID operation at stop.

| | | | |
|--------|------------------------|------------|------------|
| F14.14 | Wake up mode selection | Range: 0~1 | Default: 0 |
|--------|------------------------|------------|------------|

0: Frequency
When inverter in dormancy, wake up mode is frequency wake up
1: Pressure
When inverter in dormancy, wake up mode is pressure wake up

| | | | |
|--------|-------------------------|------------|------------|
| F14.15 | Dormancy mode selection | Range: 0~1 | Default: 0 |
|--------|-------------------------|------------|------------|

0: Frequency
Inverter dormancy mode is frequency dormancy
1: Pressure
Inverter dormancy mode is pressure dormancy

| | | | |
|--------|--------------------------|-------------|------------|
| F14.16 | Pressure feedback source | Range:00~13 | Default:00 |
|--------|--------------------------|-------------|------------|

When voltage dormancy or wake up:
Unit's place: Pressure feedback channel
0:A11
Pressure feedback given by A11

1:AI2

Pressure feedback given by AI2

2:DI7/HI pulse input

Pressure feedback given by DI7/HI

Ten's place: dormancy mode on pressure

0: Positive mode, dormancy on high pressure and wakeup on low pressure

When inverter is running, if the pressure feedback is higher than dormancy pressure, then inverter enter into dormancy.

When inverter is in dormancy, if the pressure feedback is lower than wake up pressure, then inverter wake up from dormancy

1: Negative mode, dormancy on low pressure and wake up on high pressure.

When inverter is running, if the pressure feedback is lower than dormancy pressure, then inverter enter into dormancy.

When inverter is in dormancy, if the pressure feedback is higher than wake up pressure, then inverter wake up from dormancy

Group F15 Communication Parameters

| | | | |
|--------|-----------|-----------|-----------|
| F15.00 | Baud rate | Range:0~5 | Default:1 |
|--------|-----------|-----------|-----------|

0: 4800bps

1: 9600bps

2: 19200bps

3: 38400bps

4: 57600bps

5: 115200bps

| | | | |
|--------|-------------|-----------|-----------|
| F15.01 | Data format | Range:0~3 | Default:0 |
|--------|-------------|-----------|-----------|

0: No check, data format (1-8-N-2) for RTU

1: Even parity check, data format (1-8-E-1) for RTU

2: Odd Parity check, data format (1-8-O-1) for RTU

3: No check, data format (1-8-N-1) for RTU

| | | | |
|--------|---------------|-------------|-----------|
| F15.02 | Local address | Range:1~247 | Default:1 |
|--------|---------------|-------------|-----------|

Set this drive address. 0 is broadcast address, while available addresses are 1~247.

| | | | |
|--------|-----------------------|-----------------|--------------|
| F15.03 | Communication timeout | Range:0.0~60.0s | Default:0.0s |
|--------|-----------------------|-----------------|--------------|

This parameter sets communication error detection time. When it's set to 0.0, no communication Error will be reported.

| | | | |
|--------|---------------------|---------------|-------------|
| F15.04 | Response time delay | Range:0~200ms | Default:1ms |
|--------|---------------------|---------------|-------------|

Set response time delay of this drive to the master.

| | | | |
|--------|---------------------------------|-----------|-----------|
| F15.05 | Master-slave Communication Mode | Range:0~1 | Default:0 |
|--------|---------------------------------|-----------|-----------|

0: The inverter is the slave

PC as master controls the drive. This supports all communication protocols.

1: The inverter is the master

This drive as master sends current running frequency data or set frequency data (F15.06) through RS-485 port to 2001H. Data cannot be received but sent.

| | | | |
|--------|---------------------------------------|-----------|-----------|
| F15.06 | The Master Communication Sending Data | Range:0~1 | Default:0 |
|--------|---------------------------------------|-----------|-----------|

0: Set frequency

1: Current running frequency

| | | | |
|--------|---|------------|------------|
| F15.07 | Information return when communication error | Range: 0~1 | Default: 1 |
|--------|---|------------|------------|

0: No return

1: Return

| | | | |
|--------|---|------------|------------|
| F15.08 | Group U00.00 output frequency numerical attribute | Range: 0~1 | Default: 0 |
|--------|---|------------|------------|

0:Positive and negative value (Forward: Positive value, reverse: negative value)

1: Absolute value

Group F16 Keys and Display of Keypad Parameters

| | | | |
|--------|------------------|-----------|-----------|
| F16.00 | MF.K key setting | Range:0~4 | Default:1 |
|--------|------------------|-----------|-----------|

- 0: No function
 1: Jog
 2: Forward/reverse switchover
 3: Run command sources shifted
 4: Jog reverse

| | | | |
|--------|--------------------------|-------------|------------|
| F16.01 | Function of STOP/RST key | Range:00~11 | Default:01 |
|--------|--------------------------|-------------|------------|

| | | | |
|--------|---------------------------|-------------------|---------------|
| F16.11 | Speed display coefficient | Range:0.00~100.00 | Default: 1.00 |
|--------|---------------------------|-------------------|---------------|

Unit's place: STOP/RST key function

- 0: STOP/RST key valid only when under keypad control
 1: STOP/RST key valid under any run command source

Ten's place: speed display(the value of U00.05)

- 0: Display the speed estimated
 1: Display the value(frequency multiply by speed display coefficient F16.11)

| | | | |
|--------|--------------------|-----------|-----------|
| F16.02 | Keys locked option | Range:0~4 | Default:0 |
|--------|--------------------|-----------|-----------|

- 0: Not locked
 1: Full locked
 2: Keys locked other than RUN, STOP/RST
 3: Keys locked other than STOP/RST
 4: Keys locked other than >>

| | | | |
|--------|--|------------|-----------|
| F16.03 | LED displayed parameters setting 1 on running status | Range:0~99 | Default:0 |
|--------|--|------------|-----------|

| | | | |
|--------|--|------------|-----------|
| F16.04 | LED displayed parameters setting 2 on running status | Range:0~99 | Default:6 |
|--------|--|------------|-----------|

| | | | |
|--------|--|------------|-----------|
| F16.05 | LED displayed parameters setting 3 on running status | Range:0~99 | Default:3 |
|--------|--|------------|-----------|

| | | | |
|--------|--|------------|-----------|
| F16.06 | LED displayed parameters setting 4 on running status | Range:0~99 | Default:2 |
|--------|--|------------|-----------|

Sets LED displayed parameters on running status. When a number of parameters are selected to be displayed, skim- through could be performed using key >> on keypad. 0~99 corresponding U00.00~U00.99.

| | | | |
|--------|---|------------|-----------|
| F16.07 | LED displayed parameters setting 1 on stop status | Range:0~99 | Default:1 |
|--------|---|------------|-----------|

| | | | |
|--------|---|------------|-----------|
| F16.08 | LED displayed parameters setting 2 on stop status | Range:0~99 | Default:6 |
|--------|---|------------|-----------|

| | | | |
|--------|---|------------|------------|
| F16.09 | LED displayed parameters setting 3 on stop status | Range:0~99 | Default:15 |
|--------|---|------------|------------|

| | | | |
|--------|---|------------|------------|
| F16.10 | LED displayed parameters setting 4 on stop status | Range:0~99 | Default:16 |
|--------|---|------------|------------|

Sets LED displayed parameters on stop status. When a number of parameters are selected to be displayed, skim-through could be realized via key >> on keypad. 0~99 corresponding U00.00 ~ U00.99.

| | | | |
|--------|---------------------------|-------------------|-----------------|
| F16.12 | Power display coefficient | Range: 0.0~300.0% | Default: 100.0% |
|--------|---------------------------|-------------------|-----------------|

The parameter is used to adjust the value of power displayed on keypad

| | | | |
|--------|--|----------------------|----------------|
| F16.13 | The enable difference range of U00.00 and U00.01 | Range: 0.00Hz~5.00Hz | Default:0.10Hz |
|--------|--|----------------------|----------------|

When the difference range of U00.00 and U00.01 is within the set value of F16.13, then the value of U00.00 will be stable.

Group F17 User-defined Display Parameters

| | | | |
|--------|-----------------------------------|-------------------|---------------|
| F17.00 | User-defined Display Parameter 0 | Range:00.00~49.99 | Default:00.03 |
| F17.01 | User-defined Display Parameter 1 | Range:00.00~49.99 | Default:01.01 |
| F17.02 | User-defined Display Parameter 2 | Range:00.00~49.99 | Default:01.02 |
| F17.03 | User-defined Display Parameter 3 | Range:00.00~49.99 | Default:01.08 |
| F17.04 | User-defined Display Parameter 4 | Range:00.00~49.99 | Default:01.09 |
| F17.05 | User-defined Display Parameter 5 | Range:00.00~49.99 | Default:02.00 |
| F17.06 | User-defined Display Parameter 6 | Range:00.00~49.99 | Default:02.01 |
| F17.07 | User-defined Display Parameter 7 | Range:00.00~49.99 | Default:02.12 |
| F17.08 | User-defined Display Parameter 8 | Range:00.00~49.99 | Default:03.00 |
| F17.09 | User-defined Display Parameter 9 | Range:00.00~49.99 | Default:03.01 |
| F17.10 | User-defined Display Parameter 10 | Range:00.00~49.99 | Default:04.00 |
| F17.11 | User-defined Display Parameter 11 | Range:00.00~49.99 | Default:04.01 |
| F17.12 | User-defined Display Parameter 12 | Range:00.00~49.99 | Default:04.02 |
| F17.13 | User-defined Display Parameter 13 | Range:00.00~49.99 | Default:04.03 |
| F17.14 | User-defined Display Parameter 14 | Range:00.00~49.99 | Default:05.02 |
| F17.15 | User-defined Display Parameter 15 | Range:00.00~49.99 | Default:08.01 |
| F17.16 | User-defined Display Parameter 16 | Range:00.00~49.99 | Default:08.02 |
| F17.17 | User-defined Display Parameter 17 | Range:00.00~49.99 | Default:08.03 |
| F17.18 | User-defined Display Parameter 18 | Range:00.00~49.99 | Default:08.04 |
| F17.19 | User-defined Display Parameter 19 | Range:00.00~49.99 | Default:08.05 |
| F17.20 | User-defined Display Parameter 20 | Range:00.00~49.99 | Default:08.30 |
| F17.21 | User-defined Display Parameter 21 | Range:00.00~49.99 | Default:11.10 |
| F17.22 | User-defined Display Parameter 22 | Range:00.00~49.99 | Default:13.00 |
| F17.23 | User-defined Display Parameter 23 | Range:00.00~49.99 | Default:13.01 |
| F17.24 | User-defined Display Parameter 24 | Range:00.00~49.99 | Default:13.02 |
| F17.25 | User-defined Display Parameter 25 | Range:00.00~49.99 | Default:13.08 |
| F17.26 | User-defined Display Parameter 26 | Range:00.00~49.99 | Default:13.09 |
| F17.27 | User-defined Display Parameter 27 | Range:00.00~49.99 | Default:00.00 |

| | | | |
|--------|-----------------------------------|-------------------|---------------|
| F17.28 | User-defined Display Parameter 28 | Range:00.00~49.99 | Default:00.00 |
| F17.29 | User-defined Display Parameter 29 | Range:00.00~49.99 | Default:00.00 |

F17 is user-defined parameter group. You can select the required parameters from all FR200 function codes and add them into this group, convenient for view and modification. Description of function codes FR200 User Manual Group F17 provides a maximum of 30 user-defined parameters. If "00.00" is displayed, it indicates that group F17 is null. After you enter user-defined function code mode, the displayed parameters are defined by F17.00 to F17.29 and the sequence is consistent with that in group F17.

Group F22 Virtual IO

| | | | |
|--------|---|-----------------------------------|------------|
| F22.00 | Terminal function selection of virtual VDI1 | Range: the same as funcode F04.00 | Default: 0 |
| F22.01 | Terminal function selection of virtual VDI2 | Range: the same as funcode F04.00 | Default: 0 |
| F22.02 | Terminal function selection of virtual VDI3 | Range: the same as funcode F04.00 | Default: 0 |
| F22.03 | Terminal function selection of virtual VDI4 | Range: the same as funcode F04.00 | Default: 0 |
| F22.04 | Terminal function selection of virtual VDI5 | Range: the same as funcode F04.00 | Default: 0 |

Virtual VDI1~VDI2 can be used as multifunctional digital input, they are set as common DI

| | | | |
|--------|--|--------------------|----------------|
| F22.05 | Valid status setting mode of virtual terminals | Range: 00000~11111 | Default: 00000 |
| F22.06 | Setting status of virtual VDI terminals | Range: 00000~11111 | Default: 00000 |

There are two modes to set status of virtual VDI terminal, and selected by F22.05

0:the validity of VDI depends on validity of VDO output,and VDOx uniquely bound with VDOx(x range 1-5)

1:Binary digit of F22.06 determine the status of virtual terminal respectively

| | | | |
|--------|---|--|------------|
| F22.07 | Selection of virtual VDO1 output function | 0:internal short circuited physics Dix Other:The same as F05.00 | Default: 0 |
| F22.08 | Selection of virtual VDO2 output function | 0:internal short circuited physics Dix Other:The same as F05.00 | Default: 0 |
| F22.09 | Selection of virtual VDO3 output function | 0:internal short circuited physics Dix Other:The same as F05.00 | Default: 0 |
| F22.10 | Selection of virtual VDO4 output function | 0:internal short circuited physics Dix Other:The same as F05.00 | Default: 0 |
| F22.11 | Selection of virtual VDO5 output function | 0:internal short circuited physics Dix Other:The same as F05.00 | Default: 0 |

0:Output status of VDO1~VDO5 determined by input status of DI1~DI5 on the control board, at this situation,there is a one-one correspondence between VDOx and Dix.

| | | | |
|--------|--------------------------------|---------------------|---------------|
| F22.12 | Virtual VDO1 output delay time | Range: 0.0s~6000.0s | Default: 0.0s |
| F22.13 | Virtual VDO2 output delay time | Range: 0.0s~6000.0s | Default: 0.0s |
| F22.14 | Virtual VDO3 output delay time | Range: 0.0s~6000.0s | Default: 0.0s |
| F22.15 | Virtual VDO4 output delay time | Range: 0.0s~6000.0s | Default: 0.0s |

| | | | |
|--------|--|---------------------|----------------|
| F22.16 | Virtual VDO5 output delay time | Range: 0.0s~6000.0s | Default: 0.0s |
| F22.17 | Positive and negative logic of VD0 output terminal | Range: 00000~11111 | Default: 00000 |

Positive and negative logic of VD0 output terminal:

Positive logic: If terminal is invalid, then output 0, if terminal is valid, then output 1.

Negative logic: If terminal is invalid, then output 1, if terminal is valid, then output 0.

Group U00 Status Monitoring

Group U00 is used to monitor the AC drive's running state. You can view the parameter values by using keypad, convenient for on-site commissioning, or from the host computer by means of communication (address: 0x3000~0x3020). Status monitoring parameters in the running and stop state are defined by F16.03 and F16.103.

| | | | |
|--------|------------------------|------------------------|-----------------|
| U00.00 | Running frequency | Range:0.00~Fup | Default:0.00Hz |
| U00.01 | Set frequency | Range:0.00~Fmax | Default:0.00Hz |
| U00.02 | Output voltage | Range:0~660V | Default:0V |
| U00.03 | Output current | Range:0.0~3000.0A | Default:0.0A |
| U00.04 | Output power | Range:-3000.0~3000.0kW | Default:0.0kW |
| U00.05 | Estimated Motor Speed | Range:0~60000rpm | Default:0rpm |
| U00.06 | Bus voltage | Range:0~1200V | Default:0V |
| U00.07 | Synchronous Frequency | Range:0.00~Fup | Default:0.00Hz |
| U00.08 | PLC step | Range:1~15 | Default:1 |
| U00.09 | Program Operation Time | Range:0.0~6000.0s(h) | Default:0.0s(h) |

| | | | |
|--------|--------------|---------------|-----------|
| U00.10 | PID set | Range:0~60000 | Default:0 |
| U00.11 | PID feedback | Range:0~60000 | Default:0 |

They display the PID setting value and PID feedback value.

PID setting = PID setting (percentage)

F13.03

PID feedback = PID feedback (percentage)

F13.03

| | | | |
|--------|--|-------------------|---------------|
| U00.12 | Status of DI1~DI5 digital input terminal | Range:00000~11111 | Default:00000 |
|--------|--|-------------------|---------------|

0 means terminal input status is OFF, while 1 means terminal input status is ON.

Unit's place: DI1

Decade: DI2

Hundreds place: DI3

Thousands place: DI4

| | | | |
|--------|--|--------------|-------------|
| U00.13 | Status of DI6~DI7 digital input terminal | Range: 00~11 | Default: 00 |
|--------|--|--------------|-------------|

Ten thousands place: DI5

0 means terminal input status is OFF, while 1 means terminal input status is ON.

Unit's place: DI6

Decade: DI7

| | | | |
|--------|-----------------------------------|------------------|---------------|
| U00.14 | Status of digital output terminal | Range: 0000~1111 | Default: 0000 |
|--------|-----------------------------------|------------------|---------------|

0 means terminal input status is OFF, while 1 means terminal input status is ON.

Unit's place: Y1

Decade: Y2

Hundreds place: R1

Thousands place: R2

| | | | |
|--------|-----------|-------------------|---------------|
| U00.15 | A11 input | Range: 0.0~100.0% | Default: 0.0% |
| U00.16 | A12 input | Range: 0.0~100.0% | Default: 0.0% |

| | | | |
|--------|---------------------------------|-----------------------|------------------|
| U00.17 | AI3 input | Range: 0.0~100.0% | Default: 0.0% |
| U00.18 | Keypad potentiometer input | Range: 0.0~100.0% | Default: 0.0% |
| U00.19 | HI input | Range: 0.00~100.00kHz | Default: 0.00kHz |
| U00.20 | AO1 output | Range: 0.0~100.0% | Default: 0.0% |
| U00.21 | AO2 output | Range: 0.0~100.0% | Default: 0.0% |
| U00.22 | HO output | Range: 0.00~100.00kHz | Default: 0.00kHz |
| U00.23 | Temperature of inverter | Range:-40.0~120.0 °C | Default: 0.0 °C |
| U00.24 | Accumulative power-on time | Range:0~65535min | Default: 0min |
| U00.25 | Accumulative running time | Range:0~65535min | Default: 0min |
| U00.26 | Cumulative power-on time | Range:0~65535h | Default: 0h |
| U00.27 | Cumulative running time | Range:0~65535h | Default: 0h |
| U00.28 | Count value | Range:0~65535 | Default: 0 |
| U00.29 | Length value | Range:0~65535m | Default: 0m |
| U00.30 | Linear speed | Range:0~65535m/min | Default: 0m/Min |
| U00.31 | Output torque | Range:0.0~300.0% | Default: 0.0% |
| U00.32 | PTC motor temperature detection | Range: -40~200 °C | Default: 0 °C |
| U00.35 | Power consumption | Range: 0~65535kWh | Default: 0 kWh |
| U00.36 | VDI1~VDI5 input status | Range: 00000~11111 | Default: 00000 |
| U00.37 | VDO1~VDO5 output status | Range: 00000~11111 | Default: 00000 |

Group U01 Fault Record

| | | | |
|--------|--|-------------------|---------------|
| U01.00 | Code of the latest fault | Range:0~31 | Default:0 |
| U01.01 | Running frequency when the latest fault occurred | Range:0.00~Fup | Default:0.0Hz |
| U01.02 | Output current when the latest fault occurred | Range:0.0~3000.0A | Default:0.0A |
| U01.03 | Bus voltage when the latest fault occurred | Range:0~1200V | Default:0V |
| U01.04 | Cumulative running time when the latest fault occurred | Range:0~65535h | Default:0h |

Check the information of the latest fault. See Chapter 7 for details of fault codes.

| | | | |
|--------|--|-------------------|---------------|
| U01.05 | Code of previous fault | Range:0~31 | Default:0 |
| U01.06 | Running frequency when previous fault occurred | Range:0.00~Fup | Default:0.0Hz |
| U01.07 | Output current when previous fault occurred | Range:0.0~3000.0A | Default:0.0A |
| U01.08 | Bus voltage when previous fault occurred | Range:0~1200V | Default:0V |
| U01.09 | Cumulative running time when previous fault occurred | Range:0~65535h | Default:0h |

Check the information of previous fault. See Chapter 7 for details of fault codes.

| | | | |
|--------|---|-------------------|---------------|
| U01.10 | Before-previous fault code | Range:0~31 | Default:0 |
| U01.11 | Running frequency when before-previous fault occurred | Range:0.00~Fup | Default:0.0Hz |
| U01.12 | Output current when before-previous fault occurred | Range:0.0~3000.0A | Default:0.0A |

| | | | |
|--------|---|----------------------|----------------|
| U01.13 | Bus voltage when before-previous fault occurred | Range:0~1200V | Default:0V |
| U01.14 | Cumulative running time when before-previous fault occurred | Range:0~65535h | Default:0h |
| U01.15 | Previous 3 categories of faults | The same with U01.00 | Default: Err00 |
| U01.16 | Previous 4 categories of faults | The same with U01.00 | Default: Err00 |
| U01.17 | Previous 5 categories of faults | The same with U01.00 | Default: Err00 |
| U01.18 | Previous 6 categories of faults | The same with U01.00 | Default: Err00 |
| U01.19 | Previous 7 categories of faults | The same with U01.00 | Default: Err00 |
| U01.20 | Previous 8 categories of faults | The same with U01.00 | Default: Err00 |
| U01.21 | Previous 9 categories of faults | The same with U01.00 | Default: Err00 |
| U01.22 | Previous 10 categories of faults | The same with U01.00 | Default: Err00 |
| U01.23 | Previous 11 categories of faults | The same with U01.00 | Default: Err00 |
| U01.24 | Previous 12 categories of faults | The same with U01.00 | Default: Err00 |
| U01.25 | Previous 13 categories of faults | The same with U01.00 | Default: Err00 |

Check the information of 3~13 previous fault (the fault sequence: before-previous fault, previous fault, latest fault). See Chapter 7 for details of fault code.

Chapter 7 Maintenance and Troubleshooting

FR600 inverter provides a number of warning information and protection, when a fault occurs, the protective function is activated, the inverter will stop output, inverter fault relay contact, and in the inverter displays the fault code on the display panel. Before seeking service user can press the self-examination tips in this section, analyze problems, and identify solutions. If the problem still cannot be excluded, seek services, or contact the dealer you purchase the drive with my company.

| Display | Fault Name | Possible Causes | Solutions |
|---------|----------------------------|--|--|
| Err01 | Accel overcurrent | <ol style="list-style-type: none"> 1: The output circuit is grounded or short circuited. 2: The acceleration time is too short. 3: Manual torque boost or V/F curve is not appropriate. 4: The voltage is too low. 5: The startup operation is performed on the rotating motor. 6: A sudden load is added during acceleration. 7: The AC drive model is of too small power class. | <ol style="list-style-type: none"> 1: Eliminate external faults. 2: Increase the acceleration time. 3: Adjust the manual torque boost or V/F curve. 4: Adjust the voltage to normal range. 5: Select rotational speed tracking restart or start the motor after it stops. 6: Remove the added load. 7: Select an AC drive of higher power class |
| Err02 | Decel overcurrent | <ol style="list-style-type: none"> 1: The output circuit is grounded or short circuited. 2: The deceleration time is too short. 3: The voltage is too low. 4: A sudden load is added during deceleration. 5: The braking unit and braking resistor are not installed. | <ol style="list-style-type: none"> 1: Eliminate external faults. 2: Increase the deceleration time. 3: Adjust the voltage to normal range. 4: Remove the added load. 5: Install the braking unit and braking resistor. |
| Err03 | Constant-speed overcurrent | <ol style="list-style-type: none"> 1: The output circuit is grounded or short circuited. 2: The voltage is too low. 3: A sudden load is added during operation. 4: The AC drive model is of too small power class. | <ol style="list-style-type: none"> 1: Eliminate external faults 2: Adjust the voltage to normal range. 3: Remove the added load 4: Select an AC drive of higher power class. |
| Err04 | Accel overvoltage | <ol style="list-style-type: none"> 1: The input voltage is too high. 2: An external force drives the motor during acceleration. 3: The acceleration time is too short. 4: The braking unit and braking resistor are not installed. | <ol style="list-style-type: none"> 1: Adjust the voltage to normal range. 2: Cancel the external force or install a braking resistor. 3: Increase the acceleration time. 4: Install the braking unit and braking resistor. |

| | | | |
|-------|----------------------------|---|--|
| Err05 | Decel overvoltage | <ol style="list-style-type: none"> 1: The input voltage is too high. 2: An external force drives the motor during deceleration. 3: The deceleration time is too short. 4: The braking unit and braking resistor are not installed. | <ol style="list-style-type: none"> 1: Adjust the voltage to normal range. 2: Cancel the external force or install the braking resistor. 3: Increase the deceleration time. 4: Install the braking unit and braking resistor. |
| Err06 | Constant-speed overvoltage | <ol style="list-style-type: none"> 1: The input voltage is too high 2: An external force drives the motor during deceleration. | <ol style="list-style-type: none"> 1: Adjust the voltage to normal range. 2: Cancel the external force or install the braking resistor. |
| Err07 | Bus undervoltage | <ol style="list-style-type: none"> 1: Instantaneous power failure occurs on the input power supply. 2: The AC drive's input voltage is not within the allowable range. 3: The bus voltage is abnormal. 4: The rectifier bridge and buffer resistor are faulty. 5: The drive board is faulty. 6: The main control board is faulty. | <ol style="list-style-type: none"> 1: Reset the fault. 2: Adjust the voltage to normal range. 3: Contact the agent or Frecon. |
| Err08 | Short circuit | <ol style="list-style-type: none"> 1: The output circuit is grounded or short circuited. 2: The connecting cable of the motor is too long. 3: The module overheats. 4: The internal connections become loose. 5: The main control board is faulty 6: The drive board is faulty. 7: The inverter module is faulty. | <ol style="list-style-type: none"> 1: Eliminate external faults. 2: Install a reactor or an output filter. 3: Check the air filter and the cooling fan. 4: Connect all cables properly. 5: Contact the agent or Frecon. |
| Err09 | Power input phase loss | <ol style="list-style-type: none"> 1: The three-phase power input is abnormal. 2: The drive board is faulty. 3: The lightning board is faulty. 4: The main control board is faulty. | <ol style="list-style-type: none"> 1: Eliminate external faults. 2: Contact the agent or FRECON. |
| Err10 | Power output phase loss | <ol style="list-style-type: none"> 1: The cable connecting the AC drive and the motor is faulty. 2: The AC drive's three-phase outputs are unbalanced when the motor is running. 3: The drive board is faulty. 4: The module is faulty. | <ol style="list-style-type: none"> 1: Eliminate external faults. 2: Check whether the motor Three-phase winding is normal. 3: Contact the agent or Frecon. |
| Err11 | Motor overload | <ol style="list-style-type: none"> 1: F11-17 is set improperly. 2: The load is too heavy or locked-rotor occurs on the motor. 3: The AC drive model is of too | <ol style="list-style-type: none"> 1: Set F11-17 correctly. 2: Reduce the load and check the motor and the mechanical condition. 3: Select an AC drive of |

| | | small power class. | higher power class. |
|-------|---------------------------------|---|---|
| Err12 | Inverter overload | 1: The load is too heavy or locked-rotor occurs on the motor. 2: The AC drive model is of too small power class. | 1: Reduce the load and check the motor and mechanical condition. 2: Select an AC drive of higher power class. |
| Err13 | External equipment fault | 1: External fault signal is input via DI. | Reset the operation. |
| Err14 | Module overheat | 1: The ambient temperature is too high. 2: The air filter is blocked. 3: The fan is damaged. 4: The thermally sensitive resistor of the module is damaged. 5: The inverter module is damaged. | 1: Lower the ambient temperature. 2: Clean the air filter. 3: Replace the damaged fan. 4: Replace the damaged thermally sensitive resistor. 5: Replace the inverter module. |
| Err15 | EEPROM read/write fault | The EEPROM chip is damaged. | Replace the main control board. |
| Err16 | Motor auto-tuning cancelled | Since the identification process, press STOP / RST key | Press STOP / RST key to reset |
| Err17 | Motor auto-tuning fault | 1: the motor and the inverter output terminals are not connected 2: The motor does not disengage the load 3: The electrical fault | 1: check the connection between the inverter and motor 2: The motor is disengaged load 3: Check the motor |
| Err18 | Communication overtime error | 1: The PC is not working properly 2: The communication line is not normal 3: F15 set communication parameters set incorrectly | 1: Check the PC Connection 2: Check the communication cable 3: The communication parameters are set correctly |
| Err19 | PID feedback loss | PID feedback set value is less than F13.24 | Check the PID feedback signal or set to an appropriate value F13.24 |
| Err20 | Continuous running time reached | Set the running time to reach this function | reference F05.14 Description |
| Err21 | Parameter upload fault | 1: Is not installed or is not plugged parameter copy card 2: Parameter copy card anomalies 3: The control board abnormalities | 1: a copy of the card is properly installed parameters 2: for technical support 3: for technical support |
| Err22 | Parameter download fault | 1: Is not installed or is not plugged parameter copy card 2: Parameter copy card anomalies 3: The control board abnormalities | 1: A copy of the card is properly installed parameters 2: For technical support 3: For technical support |
| Err23 | Braking unit fault | 1: The brake line failure or damage the brake pipe 2: An external braking resistor is too small | 1: Check the brake unit, replace the brake pipe 2: Increasing the braking resistor |

| | | | |
|-------|--|---|---|
| Err24 | Module temperature detection disconnection | The temperature sensor failure or cable break | For technical support |
| Err25 | Load becoming 0 | The AC drive running current is lower than F11.22 | Check that the load is disconnected or the setting F11-22 and F11-23 is correct. |
| Err26 | With-wave current limit fault | 1: The load is too heavy or locked rotor occurs on the motor. 2: The AC drive model is of too small power class. | 1: Reduce the load and check the motor and mechanical condition. 2: Select an AC drive of higher power class. |
| Err27 | Inverter soft-start relay is off | 1: The grid voltage is too low 2: Rectifier module failure | 1: Check the grid voltage 2: Demand for technical support |
| Err28 | Software version compatibility fault | 1: The upper and lower transmission module parameters in the parameter version of the control panel mismatch. | re-upload module parameters to pass down |
| Err29 | Instantaneous overcurrent | 1. Inverter output circuit being grounded or short-circuit; 2. The acceleration and deceleration time is too short; 3. Manually torque boost or V/F curve not appropriate; 4. Voltage too low; 5. Start the running motor; 6. Sudden-load in the acce process; 7. Model selection of inverter power is too small. | 1. Troubleshooting peripheral problems; 2. To increase the acceleration time; 3. Adjust the manually torque boost or V/F curve; 4. Adjust the voltage to normal range; 5. Select RPM track start or start after motor stopped; 6. Cancel sudden-load; 7. Select the inverter with larger power. |
| Err30 | Instantaneous overvoltage | 1: Input voltage is too high; 2. There is external force drag the motor to run in dece process; 3. The deceleration time is too short; 4. No installation of braking resistor. | 1: Adjust the voltage to normal range; 2. Cancel external force or install brake resistor; 3. To increase the deceleration time; 4. Install braking resistor |
| Err39 | Motor temperature too high | 1、 PTC sensor configuration not right 2、 Motor temperature protection value too small 3、 Motor temperature too high | 1、 Reset PTC sensor parameter 2、 Increase motor temperature protection value 3、 Waiting until motor is cooled |
| Err40 | The setting running time ends | 1、 Running time more than F00.25 | 1. Contact the dealer |

Chapter 8 Maintenance and Inspection

8.1 Inspection

Frequency semiconductor devices, passive electronic components, and the movement device is configured, these devices have life, even under normal working conditions, if over the useful life, some devices may have characteristic changes or failure. In order to prevent this phenomenon leads to failure and must be checked daily, periodic inspection, parts replacement and other preventative maintenance checks. After the machine installation is recommended every 3 to 4 months to conduct an inspection. If any of the following situations, please check to shorten the cycle.

- High-temperature, high-altitude environment;
- Frequent starting and stopping the environment;
- The presence of AC power or load greater volatility environment;
- Environment existed large vibration or shock;
- The existence of environmental dust, metal dust, salt, sulfuric acid, chlorine element;
- Storage environment is very bad.

8.1.1 Daily inspection

To avoid damage and shorten the life of the inverter, please confirm the following items daily.

| item | contents | Strategies |
|-----------------|--|--|
| Power supply | Check the supply voltage meets the requirements phase power supply and the presence of the phenomenon. | Press nameplate asked to solve. |
| Surroundings | Installation environment meets the requirements of Table 3-1. | Confirm the source and properly resolve |
| Cooling System | Whether the inverter and the motor is abnormal discoloration 符 heating and cooling fan status. | Confirm whether the overload, tighten the screws, if the inverter heatsink fan is dirty confirm whether the stall. |
| Motor | Whether the motor is abnormal vibration and abnormal noise. | Tightening mechanical and electrical connections and do lubricated mechanical parts. |
| Load conditions | Inverter output current is higher than the rating of the motor or inverter and lasted for some time. | Confirm whether there is an overload condition occurs confirm the correct drive selection |

Note: Do not relate jobs in the state power is turned on, otherwise there is danger of electric shock to cause death. When 演 conducting related operations, turn off the power and make sure the main circuit DC voltage has dropped to a safe level, five minutes before the related operations.

8.1.2 Regularly check

Under normal circumstances, every three months to four months to conduct a periodic inspection is appropriate, but in the actual case, combined with the use of each machine and the working environment, to determine the actual inspection cycle.

| item | contents | Strategies |
|------------------------|--|---|
| Overall | <ul style="list-style-type: none"> ● Insulation resistance check; ● environmental inspections. | <ul style="list-style-type: none"> ● fastening and replace bad parts; ● Clean improving operating environment. |
| Electrical connection | <ul style="list-style-type: none"> ● Are there wires and connection portion discolored insulation for damage, cracks, discoloration and aging signs; ● connection terminals for wear, damage, loose; ● ground checks. | <ul style="list-style-type: none"> ● Replace damaged wires; ● tighten loose terminals and replace the damaged terminal; ● measure ground resistance and tighten the corresponding ground terminal. |
| Mechanical connection | <ul style="list-style-type: none"> ● whether there is abnormal vibration and noise, fixed loose. | <ul style="list-style-type: none"> ● tightening, lubrication, replacement of bad parts. |
| Semiconductor devices | <ul style="list-style-type: none"> ● Are stained with dirt and dust; 况 ● Are there significant changes in appearance. | <ul style="list-style-type: none"> ● Clean the operating environment; ● Replace damaged parts. |
| Electrolytic capacitor | <ul style="list-style-type: none"> ● whether the leaks, discoloration, cracking, safety is exposed, swelling, cracking or leakage. | <ul style="list-style-type: none"> ● Replace damaged parts. |
| Peripheral equipment | <ul style="list-style-type: none"> ● peripherals appearance and insulation inspection. | <ul style="list-style-type: none"> ● Clean Environment 瑛 replace damaged parts. |
| Printed circuit board | <ul style="list-style-type: none"> ● Are there odor, discoloration, severe rust connector is correct and reliable. | <ul style="list-style-type: none"> ● Fastening; ● Clean the printed circuit board; ● Replace damaged printed circuit board. 况 |
| Cooling System | <ul style="list-style-type: none"> ● whether the cooling fan is broken and stall phenomenon; ● fins are not stained with garbage and dirt, dirty; ● air intake and exhaust ports are clogged or contaminated with foreign matter. | <ul style="list-style-type: none"> ● Clean the operating environment; ● Replace damaged parts. |
| Keyboard | <ul style="list-style-type: none"> ● Are there broken keyboard and display incomplete phenomenon. | <ul style="list-style-type: none"> ● Replace damaged parts. |
| Motor | <ul style="list-style-type: none"> ● The motor is abnormal vibration and abnormal noise. | <ul style="list-style-type: none"> ● fastening mechanical and electrical connections, and the motor shaft lubrication. |

Note: Do not relate jobs in the state power is turned on, otherwise there is danger of electric shock to cause death. When conducting related operations, turn off the power and make sure the main circuit DC voltage has dropped to a safe level, five minutes before the related operations.

8.2 Maintenance

All equipment, parts are all life, the right to life has been extended maintenance, but the damage cannot be resolved equipment, devices, according to the requirements of life reached or are about to reach the end of the device to be replaced.

| Part name | Life Cycle |
|------------------------|---------------|
| Fan | 2 to 3 years |
| Electrolytic capacitor | 4 to 5 years |
| Printed circuit board | 8 to 10 years |

8.2.1 Fan

When replacing the cooling fan, use the original fan, buy original fan, and please contact the dealer where you purchased the product or the company's sales department. Drive is equipped with a plurality of cooling fan models. For a number of cooling fans with inverter, To maximize the useful life of the product, when changing the cooling fan to simultaneously replace all the fans.

Fan Removal Method

1. Under pressure Figure 8-1 (a) shows a fan elastic snaps, while a little harder to pull out in parallel, remove the fan cover from the Inverter.
2. Figure 8-1 (b) shown in order to come up with the fan cover and fan, and then press the fan as shown in the medial elastic snap lead terminal, while a little harder to pull the fan lead terminal.

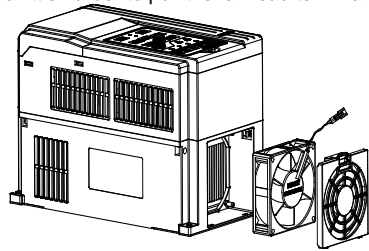
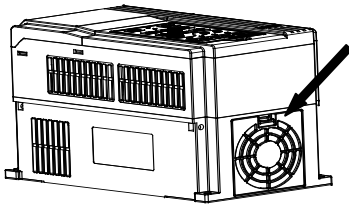

Figure 8-1 (a) Remove the fan covers
Fan Installation

Figure 8-1 (b) Remove the fan

1. Figure 8-2 (a) shown in finger pressure to the inside of the fan under the lead terminal elastic snaps, while a little harder vertically into the lead terminal, and then fan vertically into the slot.
2. Figure 8-2 (b), (c) as shown in the fan shroud assembly ramp into the hole at one end and the other end to snap into place.

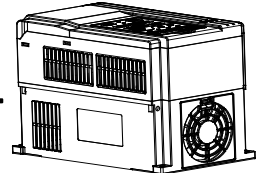
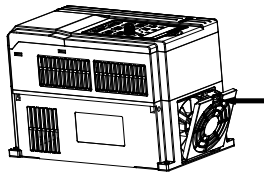
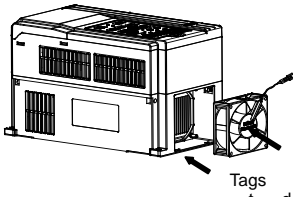

Figure 8-2 (a) Install the fan leads

Figure 8-2 (b) Install the fan cover

Figure 8-2 (c) fixed in place

Note:

- 1, do not related jobs in the state power is turned on, otherwise there is danger of electric shock to cause death. When conducting related operations, turn off the power and make sure the main circuit DC voltage has dropped to a safe level, five minutes before the related operations.
- 2, the drive to work due to the loss caused by the heat sink temperature, in order to prevent burns, do not touch the heat sink fins must be confirmed sufficiently cooled to a safe temperature below then replace the cooling fan.
- 3, in order to ensure that the inverter can maximize performance, please use the original fan.

8.2.2 Other Devices

Replacement of other devices to maintain familiarity with technology and products are very strict and must go through rigorous testing to be put into use after the replacement, so I do not recommend the user to replace the other internal components, if indeed need to be replaced, please contact the dealer where you purchased the product or our sales department.

Appendix A: Modbus Communication Protocol

1. Application Scope

1. Applicable series: FRECON FR series inverter.
2. Applicable network: Support Modbus protocol, RTU format, with single-master/multi-slave Communication network of RS485 bus.

The typical RTU message frame format:

| | | | | | |
|-------------|----------------|---------------|--------|-------|-------------|
| Start Bit | Device Address | Function Code | Data | CRC | Stop Bit |
| T1-T2-T3-T4 | 8Bit | 8Bit | n*8Bit | 16Bit | T1-T2-T3-T4 |

2. Physical Interface

RS485 is asynchronous half-duplex Communication mode. LSB has transmission priority.

Default data format of RS485 terminal: 1-8-N-1, bits rate: 9600bps.

Data format 1-8-N-1, 1-8-O-1, 1-8-E-1, optional bits rates 4800bps, 9600bps, 19200bps, 38400bps, 57600bps and 115200bps can be selected.

Shielded twisted-pair cable is recommended Communication cable to lower external interference.

3. Protocol Format

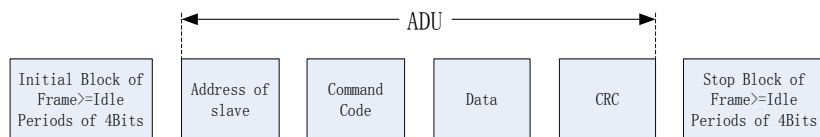

The parity in ADU (Application Data Unit) is obtained via the CRC16 parity of the 1st three Parts of ADU and switch the low bytes and high bytes. Low bytes of CRC parity go first, and high bytes of it follow in the protocol format.

4. Description of Protocol Format

4.1 Address Code

Address of slave inverter. The setting range: 1 ~ 247, 0 is broadcast address.

4.2 Command Code

| Command Code | Function |
|--------------|---|
| 03H | Read parameters and status byte of inverter |
| 06H | Write single function code or control parameter of inverter |
| 08H | Circuit diagnosis and setting |

4.3 Allocation of Register Addresses

| name | Description |
|------------------------------------|--|
| Function Code (F00.00 ~ U01.99) | <p>High byte function code group number, F00 ~ F31, U00, U01, respectively, corresponding to the high byte address is 00H ~ 1FH, 30H, 31H.</p> <p>Low byte of the group function code number, from 0 to 99 corresponding to the low byte address is 00H ~ 63H.</p> <p>For example: Modify F01.02 function code value, no power-down when storing the corresponding register address (referred to as RAM address) to 0102H.</p> <p>EEPROM is frequently modified, will reduce the life of the EEPROM. If you modify the value of the function code-down storage needs, you can make this function code is the highest position a high address. Note that this address is only to write, not read.</p> <p>For example: Modify F01.02 function code value, and the corresponding need to power down when storing the register address (referred to as EEPROM address) to 8102H.</p> |

| Function code group | RAM address high byte | EEPROM address high byte |
|---------------------|-----------------------|--------------------------|
| F00 | 0x00 | 0x80 |
| F01 | 0x01 | 0x81 |
| F02 | 0x02 | 0x82 |
| F03 | 0x03 | 0x83 |
| F04 | 0x04 | 0x84 |
| F05 | 0x05 | 0x85 |
| F06 | 0x06 | 0x86 |
| F07 | 0x07 | 0x87 |
| F08 | 0x08 | 0x88 |
| F09 | 0x09 | 0x89 |
| F11 | 0x0B | 0x8B |
| F12 | 0x0C | 0x8C |
| F13 | 0x0D | 0x8D |
| F14 | 0x0E | 0x8E |
| F15 | 0x0F | 0x8F |
| F16 | 0x10 | 0x90 |
| F17 | 0x11 | 0x91 |
| F30 | 0x1E | 0x9E |
| F31 | 0x1F | 0x9F |
| U00 (Read Only) | 0x30 | -- |
| U01 (Read Only) | 0x31 | -- |

4.4 Address and control command functions: (write only)

| Command word address | Command Function |
|----------------------|---|
| 2000H | 0001: Forward run 0002: Reverse Run 0003: Inching Forward 0004: Reverse Jog 0005: Slowdown stop 0006: freewheel 0007: Fault reset |
| 2001H | Communication setting frequency (0 ~ Fmax (Unit: 0.01Hz)) |
| 2002H | PID given range (0 to 1000, 1000 corresponds to 100.0%) |
| 2003H | PID feedback range (0 ~ 1000, 1000 corresponds to 100.0%) |
| 2004H | Torque set point (-3000 ~ 3000, 1000 corresponds to 100.0% motor rated current) |

| | |
|-------------|-----------|
| 2005 ~ 20FF | Retention |
|-------------|-----------|

4.5 The status and function of the read address Description: (read only)

| Status word address | functional status word |
|---------------------|---|
| 2100H | 0000H: parameter setting 0001H: slave run 0002H: JOG operation 0003H: learning run 0004H: Slave parking 0005H: JOG parking 0006H: Fault Status |
| 2101H | Bit0: 0 are given effective 1 Given negative effective Bit1:0 frequency output Forward 1 frequency output inversion Bit2 ~ 3: 00 Keyboard start-stop 01 terminal start-stop 10 start-stop communication 11 Reserved Bit4: 0 Factory password is invalid 1 factory password is valid Bit5: 0 user password is invalid 1 valid user password Bit6 ~ 7: 00 basic function code group 01 user-defined function code group 10 different functions with the factory default code group 11 Others |
| 2102H | Inverter current fault type |
| 2103H | Inverter current alarm type |

5 . Explanation of Command

Command code 0x03: Read parameter and status of inverter.

| ADU Item | Byte No. | Range |
|--------------------------------|---|----------------------------|
| Master requests: | | |
| Address of slave | 1 | 0 ~ 127 |
| Command Code | 1 | 0x03 |
| Register start address | 2 | 0x0000 ~ 0xFFFF |
| The number of register | 2 | 0x0000 ~ 0x0008 |
| CRC parity(Low bytes go first) | 2 | |
| Slave responds : | | |
| Address of slave | 1 | The local address |
| Command Code | 1 | 0x03 |
| Register start address | 1 | 2 <input type="checkbox"/> |
| The number of register | 2 <input type="checkbox"/> number registers | |
| CRC parity | 2 | |

Remarks: Read maximum 8 function codes consecutively.

Command code 0x06: Write single function code or control parameter of inverter.

| ADU Item | Byte No. | Range |
|------------------------|----------|-------------------|
| Master requests: | | |
| Address of slave | 1 | 0 ~ 127 |
| Command Code | 1 | 0x06 |
| Register start address | 2 | 0x0000 ~ 0xFFFF |
| The number of register | 2 | 0x0000 ~ 0xFFFF |
| CRC parity | 2 | |
| Slave responds : | | |
| Address of slave | 1 | The local address |
| Command Code | 1 | 0x06 |
| Register start address | 2 | 0x0000 ~ 0xFFFF |
| The number of register | 2 | 0x0000 ~ 0xFFFF |
| CRC parity | 2 | |

Command code 0x08: Circuit Diagnosis and Setting

| ADU Item | Byte No. | Range |
|------------------------|----------|-------------------|
| Master requests: | | |
| Address of slave | 1 | 0 ~ 127 |
| Command Code | 1 | 0x08 |
| Register start address | 2 | 0x0000 ~ 0xFFFF |
| The number of register | 2 | |
| CRC parity | 2 | |
| Slave responds : | | |
| Address of slave | 1 | The local address |
| Command Code | 1 | 0x08 |
| Register start address | 2 | 0x0000 ~ 0xFFFF |
| The number of register | 2 | |
| CRC parity | 2 | |

Remarks: Command code 0x08 is only for circuit check.

6 . CRC Parity

Sending equipment calculates CRC parity value first, and then attaches it to the sending message. Upon receipt of the message, receiving equipment will calculate CRC parity value again, and compare the operation result with received CRC parity value. If the two values are different, it indicates that there is error during transmission.

Calculation process of CRC parity:

1. Define a CRC parity register, and initialize it as FFFFH.
2. Conduct XOR calculation between the first byte of sending message and the value of CRC parity register, and then upload the result to CRC parity register. Start from address code, the start bit and stop bit will not be calculated.
3. Collect and check LSB (the least significant bit of CRC parity register).
4. If LSB is 1, shift each bit of CRC parity register rightwards by 1 bit, the highest bit filled with 0. Conduct XOR calculation between the value of CRC register and A001H, and then upload the result to CRC parity register.
5. If LSB is 0, shift each bit of CRC parity register rightwards by 1 bit, the highest bit filled with 0.
6. Repeat steps 3, 4 and 5 until completing 8 rounds of shifting.
7. Repeat steps 2, 3, 4, 5 and 6, and process the next byte of sending message. Repeat above process continuously until each byte of sending message is processed.
8. CRC parity date will be saved in CRC parity register after calculation.
9. LUT (Look-up table) method is to obtain CRC parity in the system with limited time resources. Simple CRC functions as shown in following (C language Programming):

unsigned int CRC_Cal_Value (unsigned char

□Data, unsigned char Length)

```

{
  unsigned int crc_value = 0xFFFF;
  int i = 0;
  while (Length--)
  {
    crc_value ^=      □Data++;
    for (i=0; i<8; i++)
    {
      if (crc_value & 0x0001)
      {
        crc_value = (crc_value>>1) ^ 0xa001;
      }
      else
      {
        crc_value = crc_value>>1;
      }
    }
  }
  return (crc_value);
}

```

7 . Error Message Response

Inverter will send an error message report when the master sends error data or inverter receives the error data due to the external interference.

When Communication error occurs, slave combines the highest bit 1 of command code and error code as the response to the master.

Responding data frame format when errors happened in Communication:

| ADU Item | Byte No. | Range |
|--------------------------------|----------|-----------------------------------|
| Error response: | | |
| Address of slave | 1 | 0 ~ 127 |
| Error command code | 1 | The highest bit 1 of command code |
| Error code | 1 | 0x01 ~ 0x13 |
| CRC parity(Low bytes go first) | 2 | |

Responding command code at normal Communication and error Communication

| Responding Command Code at Normal Communication | Responding Command Code at Error Communication |
|---|--|
| 03H | 83H |
| 06H | 86H |
| 08H | 88H |

Description of Error Code:

| error | Description | error | Description |
|-------|--------------------------|-------|------------------|
| 01H | Exceptional command code | 03H | Illegal Data |
| 02H | Exceptional data address | 04H | Operation failed |

For example, for U00.00 write data 50.00HZ frequency. The host sends the data frame (hex):

| | | | | | | | |
|-----|-----|-----|-----|-----|-----|-----|-----|
| 01H | 06H | 30H | 00H | 13H | 88H | 8BH | 9CH |
|-----|-----|-----|-----|-----|-----|-----|-----|

Because F00.00 is read only, inverter responds error message. Inverter responds data frame in hexadecimal format:

| | | | | |
|-----|-----|-----|-----|-----|
| 01H | 86H | 02H | C3H | A1H |
|-----|-----|-----|-----|-----|

Command code is 86H in error message, the highest bit 1 of 06H. If error code detail is 11H, it means the parameter is read only.

After responding to the error data receipt, master can revise the responding program via resending data frame or based on the error message responded by the inverter.

8. Illustration

1, No. 01 reads the output frequency value (U00.00), returned 5000, that 50.00Hz.

To send data:

01 03 30 00 00 01 8B 0A

The received data is:

01 03 02 13 88 B5 12

2, No. 01 Drive communication given frequency 30.00Hz, send the data content of 3000.

To send data:

01 06 20 01 0B B8 D4 88

The received data is:

01 06 20 01 0B B8 D4 88

3, communications sent on the 1st drive forward run command, write to the address 2000H 01

To send data:

01 06 20 00 00 01 43 CA

The received data is:

01 06 20 00 00 01 43 CA

4, No. 01 communications sent inverter deceleration stop command, the address to write to 2000H 05

To send data:

01 06 20 00 00 05 42 09

The received data is:

01 06 20 00 00 05 42 09